

STRUCTURAL HYGIENE IN HOSPITAL CONSTRUCTION

Planning recommendations for structural infection prevention in operating, emergency and intensive care and in normal nursing care

ZUKUNFT BAUEN: FORSCHUNG FÜR DIE PRAXIS | Volume 24



Imprint

Published by

Federal Institute for Research on Building, Urban Affairs and Spatial Development (BBSR)
within the Federal Office for Building and Regional Planning (BBR)
Deichmanns Aue 31–37
53179 Bonn

Supervisors

Federal Institute for Research on Building, Urban Affairs and Spatial Development
Department WB 3 "Research in Building and Construction"
Verena Kluth, verena.kluth@bbr.bund.de
Guido Hagel, guido.hagel@bbr.bund.de

Authors

Dr.-Ing. Wolfgang Sunder
Dr.-Ing. Jan Holzhausen
Univ.-Prof. Dr. med. Petra Gastmeier
Dr. rer. medic. Andrea Haselbeck
Dr.-Ing. Inka Mai, M. Sc.
(Overview of contributors on page 7)

Final editing | Accessibility PDF

ORCA Affairs GmbH, Berlin

State

2nd extended edition, August 2021

Layout

A Vitamin Kreativagentur GmbH, Berlin

Printed by

Federal Office for Building and Regional Planning, Bonn

Orders from

zb@bbr.bund.de; Keyword: HYBAU2 English

Picture credits

If not stated otherwise: Institute of Constructive Design, Industrial and Health Care Building (IKE) Technische Universität Braunschweig

Title photo: ViLevi/AdobeStock;
akf/AdobeStock: Page 36; denisismagilov/AdobeStock: Page 60; DeStagge/
AdobeStock: Page 26; edwardolive/AdobeStock: Page 49; gpointstudio/AdobeStock:
Page 38, 44; HKI/A. Schroll: Page 7, Image 2; Institute of Constructive Design, Industrial
and Health Care Building (IKE), Technische Universität Braunschweig, Tom Bauer:
Page 56; Wiebke Peitz, Charité – Universitätsmedizin Berlin, Page 7, Image 3;
Alekssei Potov/AdobeStock: Page 20; private: Page 4, Page 7, Image 1, Image 4,
Image 5; Robert Przybysz/AdobeStock: Page 16; sudok1/AdobeStock: Page 50;
th-photo/AdobeStock: Page 10; upixa/AdobeStock: Page 15; ViLevi/AdobeStock:
Page 30

Reprint and copying

All rights reserved
Reprint allowed with detailed reference only.
Please send us two specimen copies.

The publisher shall accept no responsibility for the correctness, accuracy and completeness of the information or for the observance of private third-party rights.
The views and opinions expressed do not necessarily correspond with those of the publisher.

ISBN 978-3-87994-096-7

ISSN 2199-3521

Bonn 2022

Structural Hygiene in Hospital Construction

Planning recommendations for structural infection prevention in
operating, emergency and intensive care and in normal
nursing care

2nd extended edition



Federal Ministry
for Housing, Urban Development
and Building



Federal Institute for
Research on Building,
Urban Affairs and
Spatial Development

within the Federal Office for
Building and Regional Planning



ZUKUNFT BAU
FORSCHUNGSFÖRDERUNG

The project was implemented by the Federal Institute for Research on Building, Urban Affairs and Spatial Development on behalf of the Federal Ministry for Housing, Urban Development and Building financed by funds from the Zukunft Bau Innovation Programme.

Reference number: 10.08.18.7–14.04

Project term: 09.2014–06.2018



Greeting

Dear readers,

At the end of 2021, the coronavirus pandemic still severely restricts public life. The risk of infection is particularly high in indoor areas. Most public and private buildings are not yet prepared for controlling infection risks.

Structural and technical measures can reduce the risk of transmitting infectious pathogens within buildings and thus lower the number of infections - for example in the case of nosocomial infections in hospitals. Hospitals in particular must meet the highest hygiene standards. In this context, it is obvious to also take a look at the structural and spatial framework conditions. This is the starting point for this brochure. It contains strategies and planning recommendations which apply to operating, emergency and intensive care areas.

The interdisciplinary research team led by Prof. Petra Gastmeier and Dr. Wolfgang Sunder, together with partners from the field, has succeeded in investigating structural infection prevention in a challenging way and evaluating it based on scientifically sound knowledge. The result of their work is this very informative brochure. It addresses architects, planners, hygienists and hospital operators. Due to the high demand and current developments, a second, extended edition is now available.

We will have gained a great deal if these findings contribute to the revision of the Model Hospital Building Regulation, which dates from 1976 and is completely out of date, and to the undertaking of corresponding research in this direction.

Use the recommendations for your everyday clinical practice, your hospital planning and activities on committees and panels to support hygiene safety in the interests of everyone.

I hope you enjoy this read!

Dr. Robert Kaltenbrunner

Head of the Housing and Building Department
at the Federal Institute for Research on Building, Urban Affairs and Spatial
Development (Bundesinstitut für Bau-, Stadt- und Raumforschung im Bundesamt
für Bauwesen und Raumordnung - BBSR)

Foreword

The increase in the occurrence of treatment-resistant germs in hospitals, the fear of many patients of becoming infected with one of these germs and also unpleasant occurrences due to a lack of hygiene and finally amendments to the Infection Protection Act, most recently amended in 2017, make it inevitable that hospital operators have to address the topic of hospital hygiene. This applies not only to providers and operators of hospitals but especially to architects and all professionals who have to do with the planning and construction of hospitals.

Around 500,000 patients fall ill with such infections in Germany every year. The most common hospital infections are wound infections, lower respiratory tract infections and urinary tract infections. Bloodstream infections (sepsis) and certain types of intestinal infections (Clostridium difficile infection - CDI) are also frequently observed. Many hospital infections are not only unpleasant for the patient but can also lead to an extended stay in hospital. Hospital infections therefore have considerable economic consequences. Hospital infections can even lead to or contribute to the death of the patient. It is assumed that some 10,000 to 15,000 patients per year die as a result of hospital infections [1]. Nosocomial pneumonia and sepsis in particular are associated with increased patient mortality.

In recent years, an increasing amount of attention has been given to the topic of hospital infections, not least because the proportion of patients in whom the infections are caused by multiresistant pathogens has increased. Multi-resistance means that many antibiotics which are normally used to treat these infections are no longer effective. For most multiresistant pathogens, however, reserve antibiotics still exist that can be used for therapy. Depending on the hospital and type of ward, the proportion of multiresistant pathogens among all pathogens of hospital infections is approx. 5 to 20 %. The most important multiresistant pathogens are Methicillin-resistant Staphylococcus aureus (MRSA), Vancomycin-resistant enterococci (VRE) and Gram-negative multiresistant pathogens of species Escheria coli (E. coli), Klebsiella or Pseudomonas aeruginosa.

The risk of the occurrence of new pathogens is high. New bacteria, viruses, fungi and parasites are regularly described that have the potential to cause infections in humans. The most recent influenza epidemics such as SARS and Ebola or the outbreak of the coronavirus pandemic are examples that are just as well-known as they are alarming. The occurrence of new pathogens is especially critical when they are able to spread quickly. This is shown by the experience gained so far in connection with the global spread of the coronavirus (SARS-CoV-2) since the end of 2019.

An interdisciplinary research team with experts from the fields of building (the Institute of Construction Design, Industrial and Health Care Building at the Technische Universität Braunschweig), materials science (Institute of Building Materials, Concrete Construction and Fire Safety at the Technische Universität Braunschweig) and hygiene (Institute for Hygiene and Environmental Medicine at the Charité – Universitätsmedizin in Berlin) has taken up this topic. For the "HYBAU" research project, the team investigated how structural/functional processes in hospitals can be hygienically optimised, appropriate materials used and thus new building structures designed efficiently and sustainably. Hospital providers, manufacturers of medical equipment, furniture providers and planners were also involved.

The planning recommendations presented in this publication are based on the investigations carried out in the HYBAU research project as well as on the results of other research projects in the field of structural hygiene. With these recommendations, building structures in hospitals can be designed in such a manner that they can have a sustained preventive effect on infections amongst patients and hospital staff. Special consideration is given to the areas of surgery, emergency admission to the intensive care unit and normal nursing

care. The recommendations worked out here all share the aim of supporting patients as well as medical and nursing staff in their day-to-day procedures in a hygienic environment. This is supported by building structures, which strengthen spatial orientation and clarity, which reduce distances between hygiene-relevant rooms, or which can react flexibly to changes.

The authors

Dr.-Ing. Architekt Wolfgang Sunder
Dr.-Ing. Architekt Jan Holzhausen
Univ.-Prof. Dr. med. Petra Gastmeier
Dr. rer. medic. Andrea Haselbeck
Dr.-Ing. Inka Mai, M. Sc.

Contributors

Authors:

Dr.-Ing. Wolfgang Sunder, Dr.-Ing. Jan Holzhausen
Institute of Construction Design, Industrial and Health Care Building
(Institut für Konstruktives Entwerfen, Industrie- und Gesundheitsbau - IKE)
Technische Universität Braunschweig (Project Management)
Univ.-Prof. Mag. Arch., M. Arch. Carsten Roth

Univ.-Prof. Dr. med. Petra Gastmeier, Dr. rer. medic. Andrea Haselbeck
Institute of Hygiene and Environmental Medicine, Charité Berlin

Dr.-Ing. Inka Mai, M. Sc.
Institute of Building Materials, Concrete Construction and Fire Safety
(Institut für Baustoffe, Massivbau und Brandschutz – IBMB)
Technische Universität Braunschweig
Univ.-Prof. Dr.-Ing. Dirk Lowke

Further contributors:

Till Griesemann, M. Sc. Architecture
Lars Koop, M. Sc. Architecture
Reuven Zweigel, M. Sc. Architecture
Kirsten Remmers, BA. Sc. Architecture,
Institute of Constructive Design,
Industrial and Health Care Building (IKE)
Technische Universität Braunschweig

Professional supervision:

Guido Hagel
The Federal Institute for Research on Building, Urban Affairs and Spatial
Development, Bonn
Department WB 3 “Research in Building and Construction”

Short biographies

Dr. Wolfgang Sunder

Wolfgang Sunder is post-doctoral architect and studied in Münster, Zurich and Berlin. As a scientific assistant at the Technische Universität Braunschweig's Institute of Constructive Design, Industrial and Health Care Building, he has been in charge of various research projects in the area of healthcare architecture and design since 2008 and advises hospital operators on their strategic alignment. He has been responsible for the area of construction within the "InfectControl 2020" research consortium since 2013. He is the co-author of the volume entitled "Zukunft.Klinik.Bau.Strategische Planung von Krankenhäusern". (Hospital Construction of the Future. Strategic Hospital Planning) which was published in 2015.



Dr. Jan Holzhausen

Jan Holzhausen completed his diploma degree in architecture at the Technische Universität Braunschweig in 2002 and gained two awards (the Fritz Schumacher Award and the Georg Ludwig Friedrich Laves Prize). He has been active in a planning capacity as a freelance architect since 2006. At the Technische Universität Braunschweig's Institute of Constructive Design, Industrial and Health Care Building, he has taught and conducted research as a scientific assistant and lecturer since 2006. He developed the new research focus of healthcare architecture with detailed projects in the field of strategic planning and structural infection prevention.



Prof. Dr. Petra Gastmeier

Prof. Dr. Petra Gastmeier is a medical specialist for hygiene and environmental medicine. After her post-doctoral qualification in 1999, she worked for seven years as a C3 professor at Hanover Medical School. She has been Director of the Institute for Hygiene and Environmental Medicine at the Charité – Universitätsmedizin in Berlin since 2008 and at the same time Head of the National Reference Centre for the Surveillance of Nosocomial Infections.



Dr. Andrea Haselbeck

Andrea Haselbeck, née Stiller, completed her degree in veterinary medicine at the Freie Universität Berlin and took her doctorate at the Institute for Hygiene and Environmental Medicine at the Charité – Universitätsmedizin in Berlin on the subject of infection prevention as part of the interdisciplinary "HYBAU+" project. She has worked at the International Vaccine Institute in Seoul since the beginning of 2017 with a focus on the surveillance and prevention of enteric infectious diseases in developing countries in Asia and Africa.



Dr. Inka Mai

Inka Mai took a degree in industrial and constructional engineering at the Technische Universität Braunschweig with stays abroad in Sweden and the USA. She has been Head of the Working Group for Building Materials at the Institute for Building Materials, Concrete Construction and Fire Safety since 2013. One of her research areas is the surface analysis of solid materials and structural hygiene in healthcare institutions.



Funding agencies and collaborators

Hospital operators



Zukunft Bau Innovation Programme



Sana Kliniken AG

Sana Kliniken AG, Ismaning



Schön Klinik Verwaltung GmbH, Prien am Chiemsee



Städtisches Klinikum Braunschweig gGmbH

Architektengruppe Schweitzer+Partner

Schweitzer & Partner Architect Group, Braunschweig



Objectmöbel-concept UG, Lüdinghausen



Deutsches Kupferinstitut Berufsverband e. V.



Franz Kaldewei GmbH & Co. KG, Ahlen

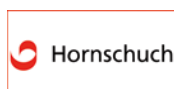

Konrad Hornschuch AG, Weissbach



Kusch+Co GmbH & Co. KG, Hallenberg



Meiko Maschinenbau GmbH & Co. KG, Offenburg



OWA Odenwald Faserplattenwerk GmbH, Amorbach



Reiss Büromöbel GmbH, Bad Liebenwerder



Resopal GmbH, Groß-Umstadt



Saint-Gobain Glass France, Courbevoie/Aachen



Sika Deutschland GmbH, Stuttgart



Tarkett Holding GmbH, Frankenthal



Vorwerk & Co. Teppichwerke GmbH & Co. KG, Hameln

Planners and advisors

Outfitters and material manufacturers

Content

Challenges	10
Hospital-specific infections	16
Systematic literature review on selected constructive measures	20
Laws, standards and guidelines.	26
General recommendations.	30
Materials in general	36
Operating theatre	38
Central emergency department (A&E)	44
Intensive care unit (ICU)	50
Normal care ward.	56
General equipment	60
Conclusion	62
Appendix	63
Questionnaire	64
Abbreviations.	79
Glossary.	80
Literature	84



Challenges

The structure of hospital buildings is subject to change, depending on medical development, societal requirements and progress in architecture and building. This chapter provides an overview of relevant challenges that have had an impact on the hospital and in particular on the area of structural hygiene over the past few decades [2].

Increase in nosocomial infections and multiresistant germs

In hospitals, an increase in seriously ill patients infected with infectious or nosocomial pathogens is to be expected. The focus here is on the intensive care units in particular, with their large number of invasive systems. At the same time, a dramatic increase in the amount of MRSA or nosocomial infectious pathogens with substantial spreading potential has been observed in recent years [3]. In addition, the number of antibiotics available will be significantly limited in the near term, since those companies that are capable of independently developing antibiotics along the clinical phases through to their use by doctors have dropped from 18 in 1990 to four in 2011 [Fig.1]. There has also been a concurrent increase in antibiotic consumption, particularly in reserve antibiotics. The cause for this, among others, is that many patients expect their doctors to prescribe antibiotics when they have a fever or other symptoms of infection.

Top image:

Source: th-photo/AdobeStock

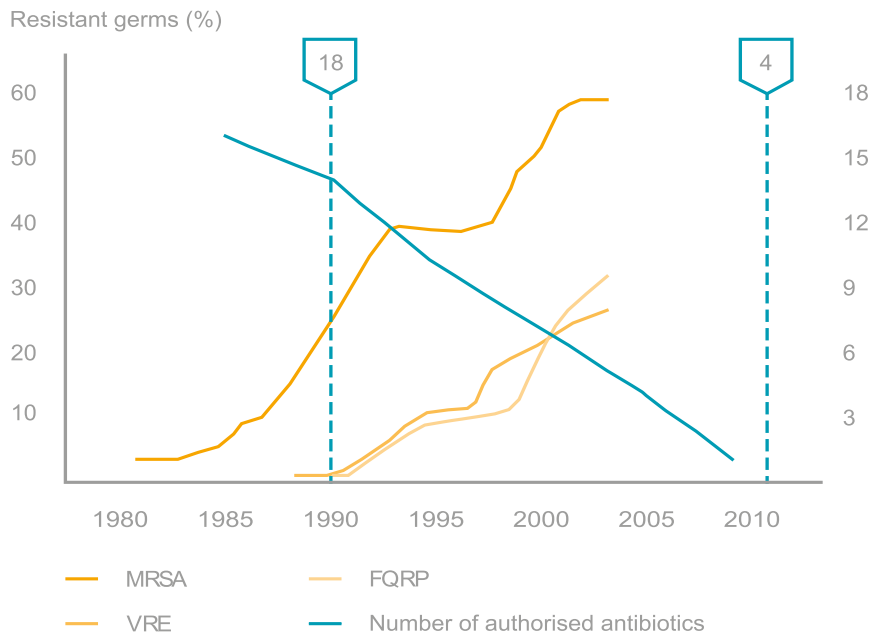

Fig 1: Number of companies capable of developing antibiotics to market launch. Number of authorised antibiotics and increase of multiresistant microbial strains

New pathogens

The risk of the occurrence of new pathogens is high. New bacteria, viruses, fungi and parasites are regularly described that have the potential to cause infections in humans. The latest influenza epidemics, SARS or the outbreak of EHEC are examples that are just as well-known as they are alarming. The occurrence of new pathogens is especially critical when they are able to spread quickly. Routine medical care is not prepared for diagnosing new pathogens, as most methods are based on detecting known pathogens. This is further complicated by the fact that the normal nursing care facilities and in particular the intensive care facilities have inadequate isolation facilities for infected patients.

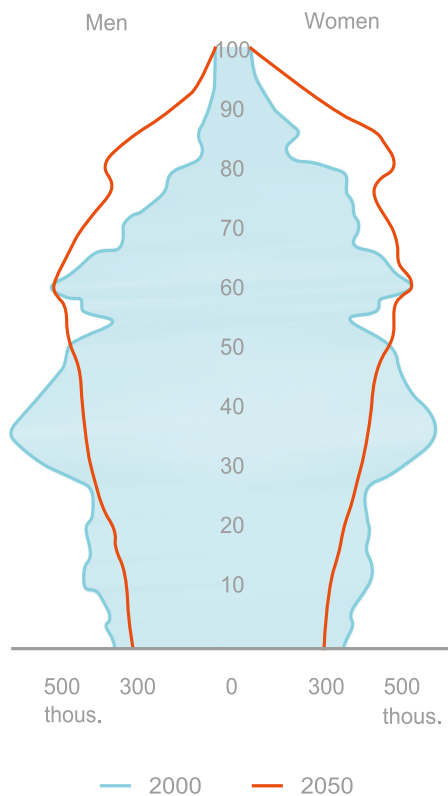

Fig 2: Population development in Germany

Demographic change: Since 1972, the mortality rate in Germany has been higher than the birth rate [Fig.2], so that the total population figure is declining. At the same time, the proportion of elderly people is increasing compared to that of younger people due to higher life expectancy. An increasing number of older people have little or even no chronic diseases or disabilities until they are around 80 years old. A major challenge with this population group is the significant increase in the number of immunosuppressed patients with concomitant diseases and their proper accommodation in the nursing wards. Since the immune system of these people is weakened by a chronic underlying illness or by the administration of certain medicines, they require more protection against infections.

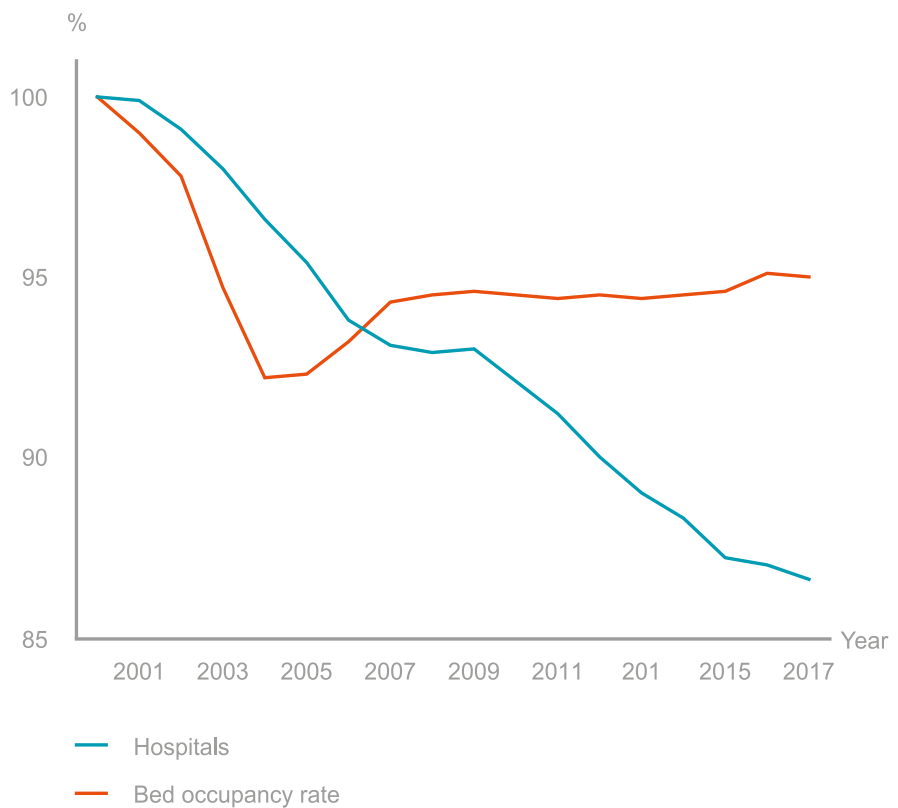

Fig 3: Development in the number of hospitals and bed occupancy rate in Germany from 2000 to 2017

Decrease in the number of hospitals and increase in bed occupancy rates: The competitive pressure between German hospitals, the new Hospital Financing Act [3] and the Diagnosis Related Groups (DRG) case-based flat-rate reimbursement system, which was introduced in 2004, have not only led to a permanent reduction of the number of hospitals in Germany, but also to a reduction in the duration of the hospitalisation of patients. There has been a simultaneous increase in the number of inpatients treated, calculated per hospital bed [Fig.3].

Increased need for medical staff

For years, costs in the German hospital sector have been climbing continuously - by about three per cent per year on average over the past ten years. Between 2000 and 2008, the overall increase totalled 21%. In 2008, the costs amounted to 62 billion euros [4]. The largest proportion of total costs are personnel costs, which account for about 60 per cent on average. The change in the demands of patients and the services provided to them have caused a strong increase in medical staff (doctors, nurses and administration) over the last few decades. The rise in personnel costs is in turn mainly attributable to a considerable increase in medical services, while the growth in the costs of nursing services was only very moderate. The nursing workforce has been continuously increased, especially over the last ten years. [Fig.4] [4].

Employees in thousands

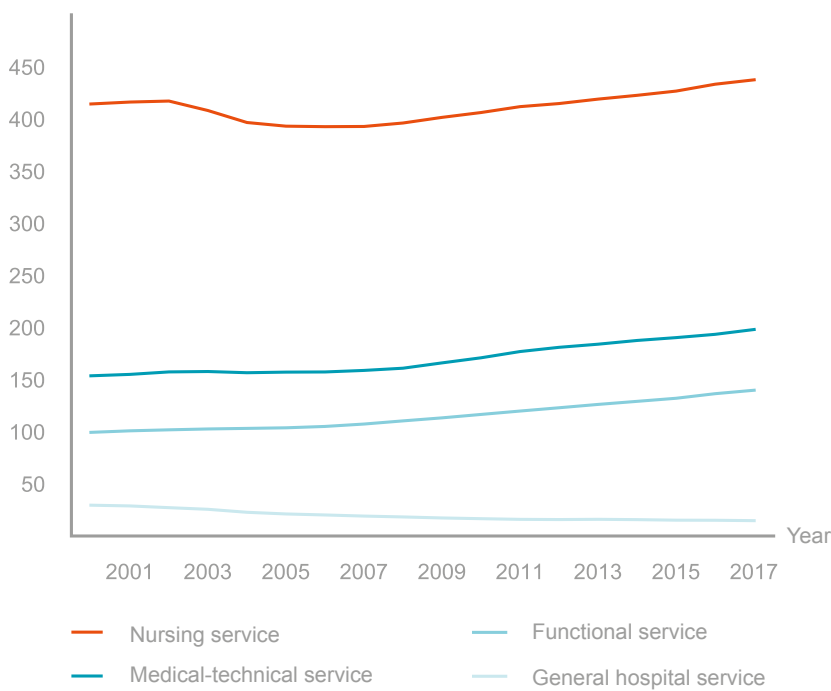

Fig 4:
Number of full-time employees
in German hospitals
from 2000 to 2017

This is contrasted by an acute lack of qualified staff: Today, there is already a shortage of qualified personnel in all nursing professions. However, official data on the number of all unfilled positions in the nursing professions is not available. Indications of existing bottlenecks can be seen in the qualified staff shortage analysis of the German Federal Employment Agency. In 2018, for every 100 registered jobs for examined geriatric nurses and specialists (outside temporary employment), there were only 29 unemployed people; for every 100 registered jobs for examined healthcare nurses, there were only 48 unemployed people [Fig.5].

Number of unemployed people per 100 registered job vacancies

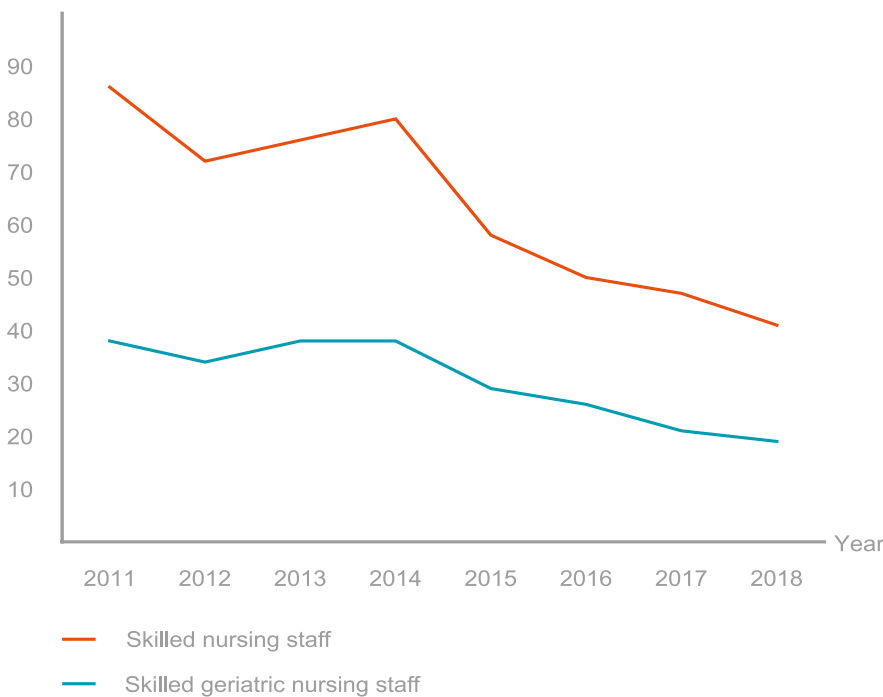

Fig 5:
Relation between the shortage of qualified
nursing staff and unemployed people

Innovations in medical technology and new forms of treatment: With the development of new diagnostic and therapeutic procedures, examination and treatment facilities were split off from the nursing wards. At the same time, the performance on the individual patient rose strongly. Recent years have also seen the establishment of new tiered forms of treatment such as semi-inpatient treatment, pre- and post-inpatient care, etc., which are steadily taking the place of the traditional form of nursing. Furthermore, the number of intensive care beds both at university hospitals and general hospitals has experienced a strong increase: The number of all intensive care beds in Germany rose from 20,000 to 27,000 during the period from 1991 to today [5], [6].

Increase in dementia patients

In addition to the constantly increasing number of elderly patients, the risk of becoming ill with dementia will also rise [Fig.6]. In Germany, a total of approximately 1 million people aged 65 and older currently suffer from dementia, which corresponds to around 7 per cent of this age group. The number of new cases increases by about 200,000 every year and will double to more than 2 million by 2050. This in turn will lead to an increase in the requirement for care and a higher need for nurses, since the automation options in this field are limited.

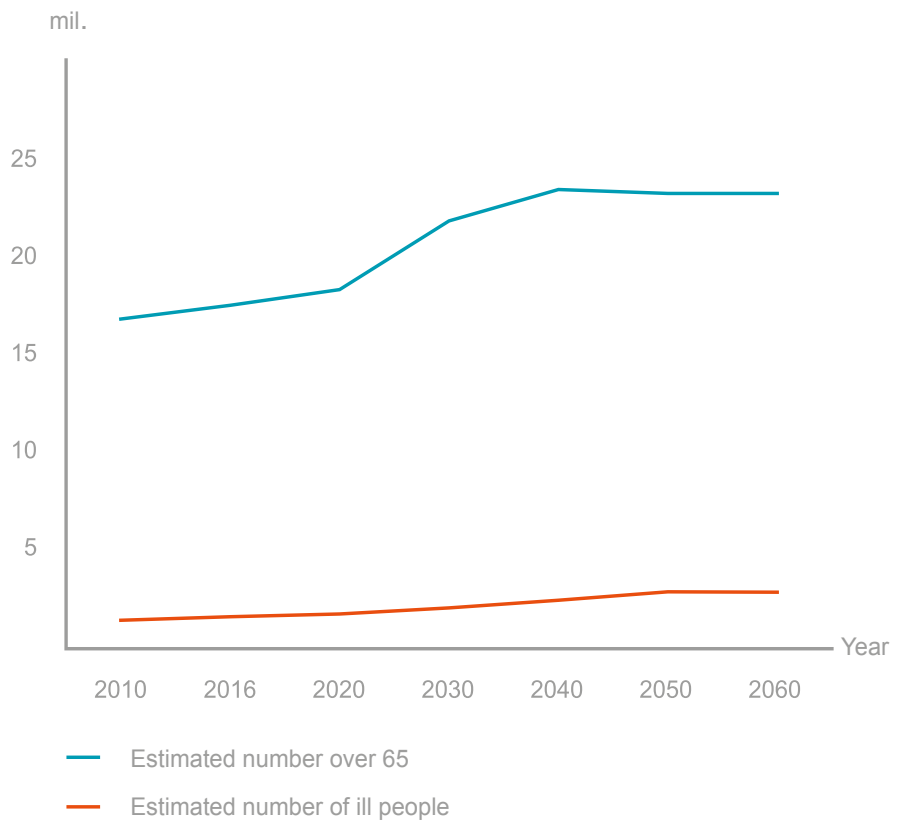

Fig 6: Predicted development in the number of dementia patients compared with the over 65-year-olds in Germany from 2010 to 2060 in millions

Right-hand image:
Source: upixa/AdobeStock



Hospital-specific infections

Introduction

Hospital-specific or nosocomial infections are infections which did not exist when the patient was admitted to hospital. The patient must not have been infected with the respective micro-organisms at this time. Infections have been sub-classified to make recording simpler: Those which already exist during the first two days in hospital are regarded as having been brought in and those which occur as from the third day in hospital are classified as nosocomial.

How do hospital infections come about?

The human body consists of approximately 10^{14} of bacteria and thus contains more bacteria than body cells. These bacteria in their entirety are called the microbiome. Most bacteria are to be found in the alimentary canal and have a central function here in digestion and the production of important metabolic products. Very many bacteria are also regularly to be found on the skin and the mucous membranes. As a result of invasive medical procedures such as injections, infusions, venous catheters, urinary catheters or intubation for artificial ventilation, this bodily bacterial flora can easily penetrate into body areas such as the blood stream, the lungs or the urinary tract which are normally sterile and where intruding

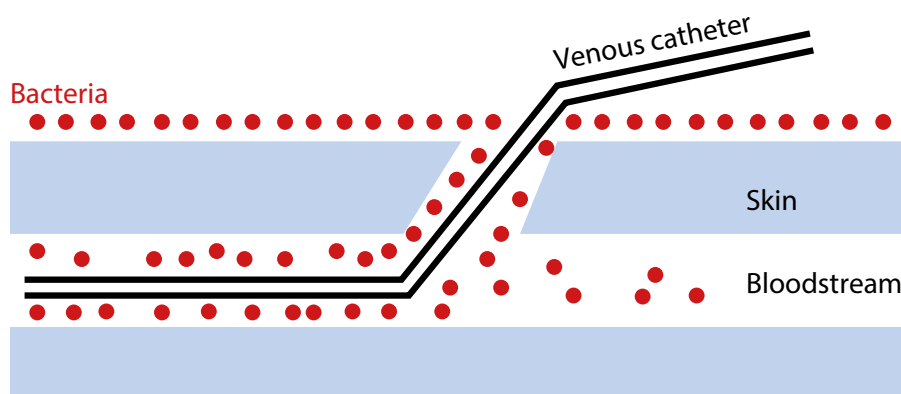

Fig 7:

Occurrence of bloodstream infections by bacteria which are situated on the skin.

Bacteria can easily get into the bloodstream along entry tracks such as venous catheters.

Top image:

Source: Robert Przybysz/AdobeStock

bacteria can easily lead to an infection [Fig. 7]. Most hospital infections are therefore of an endogenous nature and can also only be prevented to a certain extent, by for example using such invasive procedures very restrictively.

Some hospital infections come about due to pathogens which are brought in to the patients from outside, for example by direct or mostly indirect contact with other patients or with hospital staff (exogenous infection). Generally, less than 20 to 30% of hospital infections are of an exogenous nature [7], [8].

In particular the hands of the staff and the transmission route via the shared use of instruments or objects play the main role here. Hence, pathogens are predominantly transmitted by contact and only in a few cases by air [Fig. 8]. If pathogens are bound to droplets, the infection is termed a droplet infection. Few pathogens are able to float freely in the atmosphere; such infections are referred to as airborne infections.

The hospital air or water have little significance in the development of hospital infections.

With suitable structural measures it is possible to reduce the proportion of exogenous infections. In an environment in which the patient feels well and is not exposed to stress in addition to their illness, it is possible under certain circumstances to reduce a small proportion of the endogenous infections as well.

It is primarily the transmission of airborne infections which can be prevented by means of constructional conditions (e.g. single rooms with and without an airlock). It can be assumed that this proportion of hospital infections is extremely low (probably < 3%). A certain advantage of single room accommodation is assumed with regard to the contact transmission of infectious pathogens. This is justified in that the separate room could be an additional factor as a reminder to consistently disinfect hands. The single room is expected to be an advantage against infectious pathogens which can also be transmitted through the joint use of sanitary facilities.

Location and time of occurrence of hospital infections

As a rule the proportion of patients with hospital infections increases with the size of the hospital. Hospitals at the end of the treatment chain more frequently have to admit patients who have a greater risk of catching such infections due to their underlying diseases.

Hospital infections occur above all in those areas of the hospital where treatment is associated with especially invasive procedures (e.g. intensive care units) or where there are patients whose immune systems are especially weakened due to their underlying diseases or in the course of medical treatment (e.g. oncology wards or wards with transplant patients). Especially invasive procedures of course include operations. Therefore, infection prevention also has a high priority in this area [Fig. 9].

Hospital infections occur with relatively constant frequency all year round. Seasonal fluctuations occur only with individual infection and pathogen types. Post-operative wound infections, for example, are more often seen in the summer. Norovirus infections occur more often in the winter.



Fig 8:

Transmission routes of infection pathogens in the hospital. The majority of pathogens are transmitted by physical contact, to a lesser extent by droplet infection (e.g. influenza) or – extremely rarely – through direct inhalation (e.g. with measles, chicken pox and tuberculosis).

Fig 9:
Different starting points for the constructional isolation of patients in hospitals. Some patient groups (e.g intensive care patients) can be assigned to both categories.

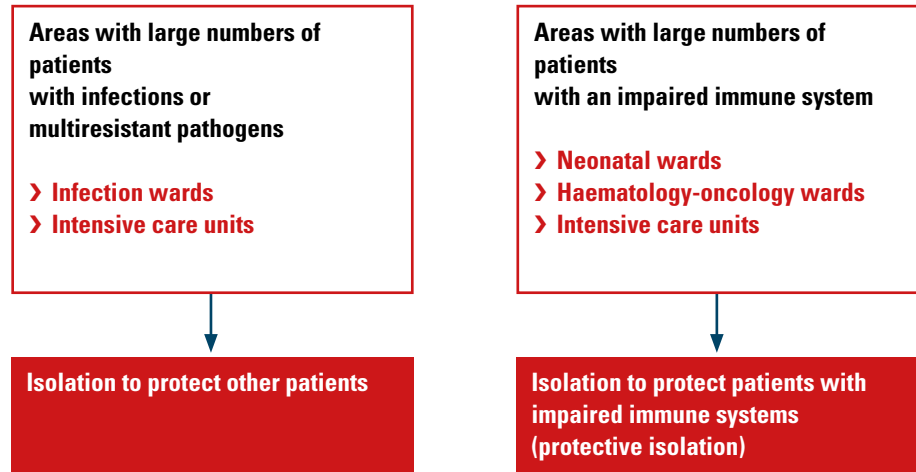

Hygiene measures in hospitals: vertical and horizontal prevention strategies

Generally, a distinction is made between horizontal and vertical prevention measures. Horizontal measures are those which have to be implemented equally for all patient groups. The most important example of this is that hands must be disinfected before and after every patient contact as well as additionally before aseptic activities such as manipulations to the venous catheter or when changing dressings. Cleaning and disinfection are also horizontal measures just as much as targeted and conservative handling of antibiotics (antibiotic stewardship). Vertical prevention measures are those which are carried out if it is known that the patient has a particular infection or is colonised with certain pathogens (e.g. multiresistant pathogens). Screening for certain pathogen types is also part of vertical preventive measures if certain additional measures are thus combined, for example the decolonisation of patients' pathogens which is only possible with a few pathogen types (e.g. MRSA), or accommodating patients in single rooms [Fig. 10].

Beyond this, preventive measures may differ in relation to different patient groups and their risks. Hospitals employ specialist hygiene staff to implement the most suitable preventive measures. Nursing staff with corresponding specialist training (hygienists) are employed in almost all hospitals. Larger hospitals additionally employ dedicated hospital hygienists. These are doctors with the relevant specialism.

Fig 10:
Overview of vertical and horizontal preventive measures

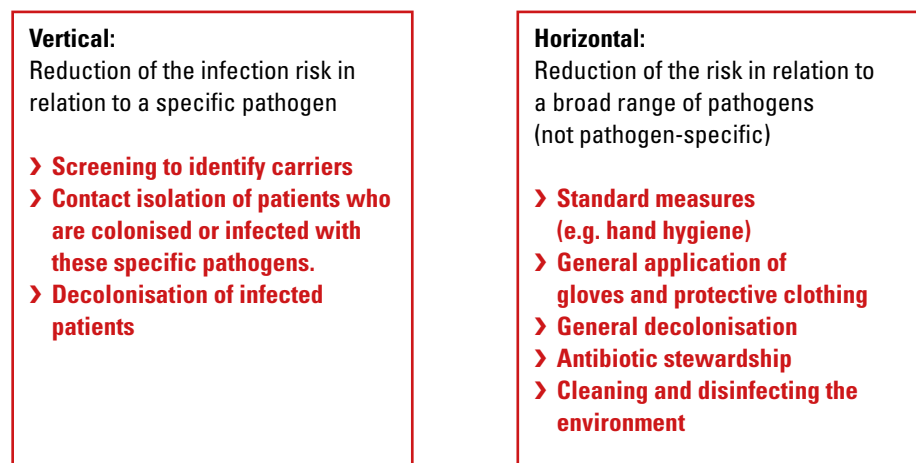

The main guidelines for infection prevention in Germany result from the Infection Protection Act and the respective state hygiene regulations. The Commission for Hospital Hygiene and Infection Prevention (Kommission für Krankenhaushygiene und Infektionsprävention - KRINKO) at the Robert Koch Institute (RKI) is a committee of experts which regularly works out suitable recommendations on infection prevention for certain groups of patients or for specific diseases, based on existing specialist literature and expert knowledge.

Due to the great significance of medical aids or equipment such as venous catheters, urinary catheters, intubation tubes etc. for infection prevention, most KRINKO recommendations are concerned with handling these aids in such a way as to avoid infection. Further recommendations concentrate on measures to prevent the spread of certain pathogens. Structural aspects of infection prevention rarely come to the fore. This is because the influence of structural measures in preventing the majority of infections is probably low. Furthermore, few studies have scientifically investigated the influence of structural measures on the occurrence of hospital infections.

Systematic literature review on selected constructive measures

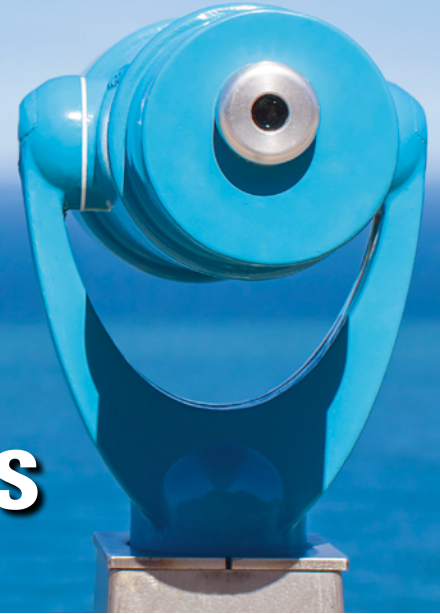

Current literature discussing the influence of structural measures on the occurrence of nosocomial infections or the spread of multiresistant pathogens was investigated systematically [4]. Accordingly, three questions were considered:

- 1) Does the location of the hand disinfectant dispenser in the patient's room influence hospital staff hand hygiene compliance and/or the nosocomial infection rate?**
- 2) Do single-bed rooms reduce the rate of transmission/infection of nosocomial infections and/or multiresistant pathogens?**
- 3) Does a larger number of square metres per bed or a greater distance between the beds in a multi-bed room have an influence on the transmission/infection rate of infection pathogens?**

A systematic literature search was performed. A total of 7,677 articles from controlled studies was found with the help of the scientific databases MEDLINE and EMBASE and the Cochrane register, and 59 additional studies were identified with other sources. After reading the title and abstracts, 170 articles remained for further analysis. Ultimately, 15 studies were able to be utilised for the systematic review [Fig 11 Table 1].

In relation to question 1, this review included all studies which had investigated the end points of hand hygiene compliance or hand disinfectant use.

Studies which investigated hand washing were not included. Studies which used multi-mode interventions were not included. All studies with the end point bacteraemia were summarised in the second meta-analysis.

A meta-analysis which included all new studies also came to the conclusion that single rooms represent a significant advantage compared to multiple-bed rooms. The associated illustrations are to be found in Stiller et al. [9].

When examining question 2, studies were included which investigated the end points of nosocomial infections (general or specific infections or pathogen types), as were studies treating the acquisition of multiresistant pathogens as the end point. At the same time single-bed rooms were compared with multi-bed rooms and "open wards". Studies in

Top image:

Source: Aleksei Potov/AdobeStock

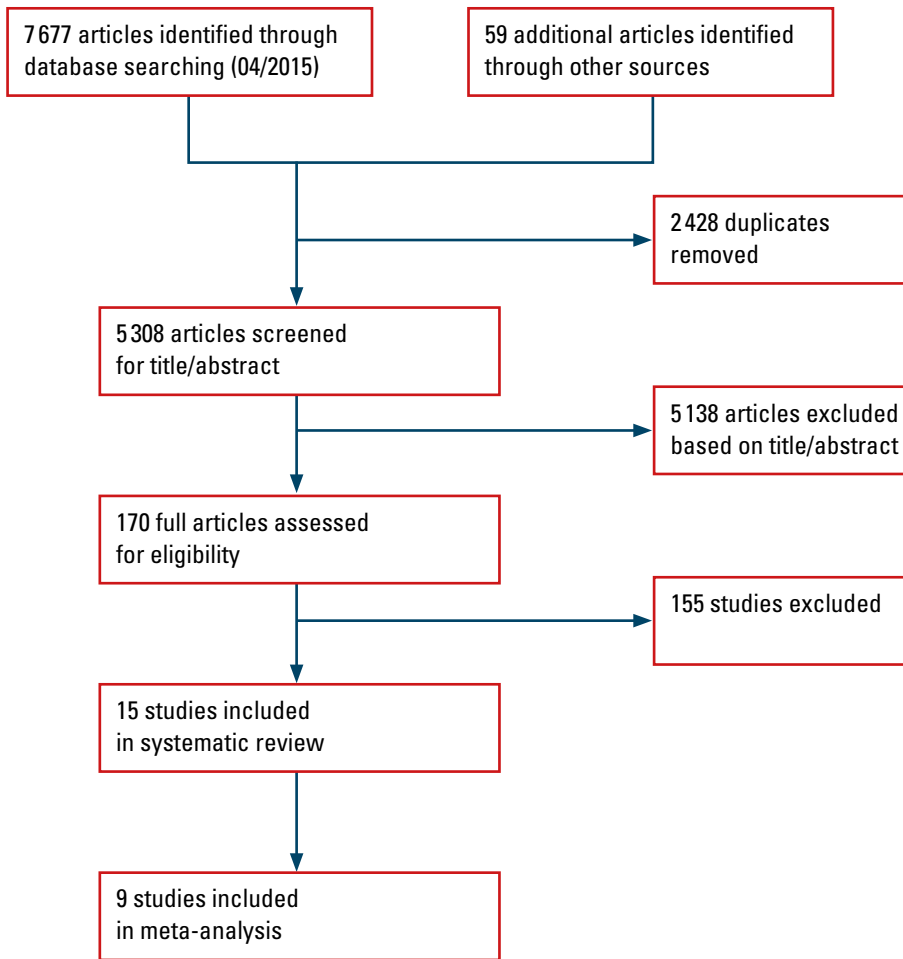

Fig 11: Literature search strategy for the systematic review. The search algorithms for the individual questions are to be found in Stiller et al.'s publication [4].

which patients were isolated or cohorted because of already existing infections were not included. Studies which investigated different bundles of measures were also excluded. Studies with other end points such as the psychological effects of accommodating patients, economic aspects or the influence on medical errors were also not included.

With regard to question 3, studies with the end points of nosocomial infections or the acquisition of multiresistant pathogens were also included. Studies which examined surface contamination in relation to the size of the room were excluded. Studies which investigated outbreak situations of these factors were also not included.

Results of the systematic review for question 1)

Does the location of the hand disinfectant dispenser in the patient's room influence hospital staff hand hygiene compliance and/or the nosocomial infection rate?

Yes, the improvement of hand hygiene compliance would be given with direct availability/visibility.

After using the search strategy detailed above and applying the inclusion and exclusion criteria mentioned, three studies remain for the review. In two studies, the end point was hand hygiene compliance and in the third it was hand disinfectant consumption. In all three intervention studies with a before-and-after design, it was possible to show that hand hygiene could be improved by installing a hand disinfectant dispenser close to the bed.

Study	Setting	Study aim	Design	End point
Birnbach et al. 2010	Replica patient room	Investigation of the effects of localisation of hand disinfectant dispensers	Intervention studies	Hand hygiene compliance
Giannitsioti et al. 2009	Internistic ward			
Thomas et al. 2009	Surgical intensive care unit			Hand disinfectant consumption
Ben-Abraham et al. 2002	Paediatric ward	Investigation into the association of single room and multi-bed rooms and nosocomial colonisation and infections	Intervention studies	Nosocomial infection, bacteraemia
Bracco et al. 2007	Surgical intensive care unit			Bacteraemia, acquisition of MRSA/pseudomonas
Ellison et al. 2014	General medical ward			Infection with acquisition of MRSA, CDI, VRE
Julian et al. 2015	Neonatal intensive care unit			Confirmed late sepsis, acquisition of MRSA
Lazar et al. 2015	Paediatric intensive care unit			Bacteraemia
Levin et al. 2011	Interdisciplinary intensive care unit			Bacteraemia, acquisition of multiresistant pathogens
McManus et al. 1994	Burns unit			Bacteraemia
Mulin et al. 1997	Surgical intensive care unit			Infection with <i>Acinetobacter baumannii</i>
Vietri et al. 2004	Interdisciplinary intensive care unit			Acquisition of MRSA
Jones et al. 2012	Neonatal intensive care unit/special newborn intensive care unit			Investigation into the association of surface area per child's bed and infection rates
Jou et al. 2015	All wards except intensive care units	Investigation into the association between patient room size and nosocomial infection rates	Case control study	<i>Clostridium difficile</i> infection (CDI)
Yu et al. 2007	All wards except paediatrics	Investigation of risk factors for nosocomial SARS outbreaks	Case control study	Serious acute respiratory syndrome (SARS)

Table 1:

Overview of the studies included.

The references are to be found in the original publication by Stiller et al. [5].

Results of the systematic review for question 2)

Do single-bed rooms reduce the rate of transmission/infection of nosocomial infections and/or multiresistant pathogens?

After using the search strategy detailed above and applying the inclusion and exclusion criteria mentioned, nine studies remained for the review. All studies but one were performed in intensive care units. Most studies had a before-and-after design, i.e. after recording a baseline ('before') infection rate, the ward moved to a new building with single rooms or the ward was converted accordingly. After the reopening of the ward, the infection rates were recorded again and compared to the initial situation. Three studies also had parallel control groups. A total of six studies show a significant advantage of single-bed rooms with regard to the end points of nosocomial infections or the acquisition of multiresistant pathogens. Three studies were unable to find any influence. The meta-analysis of the two studies with the endpoint acquisition of multiresistant pathogens demonstrated a significant benefit of single-bed rooms.

Results of the systematic review for question 3)

Does a larger number of square metres per bed or a greater distance between the beds in a multi-bed room have an influence on the transmission/infection rate of infection pathogens?

There is not enough evidence for a definite statement.

After the literature search and applying the inclusion and exclusion criteria, only three studies remained. These refer to various end points (sepsis, Clostridium difficile infection (CDI) and severe acute respiratory syndrome (SARS)). In the first study the sepsis rates before and after the newly born intensive care unit was moved to much larger premises were determined and there was a significant reduction in the sepsis rate. In the second study it was established with the aid of a case–control study that the CDI rate was higher if patients were accommodated in larger rooms. In the third study, which was carried out during the SARS outbreak in China, it became apparent that distances of < 1 m between beds were associated with a significantly higher risk of acquiring SARS.

National and international approaches to the provision of hand disinfectant dispensers

Adequate hand disinfection is one of the decisive factors in avoiding the transfer of infection pathogens from one patient to another in hospital. Recommendations were published by the World Health Organisation (WHO) many years ago which stated that an adequate number of hand disinfectant dispensers should be located close to beds in patient rooms [10]. This was confirmed by our review.

Implementing this factor is simple. According to the guidelines of the “Clean Hands Campaign”, one disinfectant dispenser per bed is demanded in intensive care units. For normal care wards, at least one dispenser for two beds is specified which should be set up in such a manner that staff only have a short distance to the dispenser when working at either bed (generally between the two beds). However, an analysis performed by our group in 621 hospitals in 2015 showed that the required proximity of hand disinfectant dispensers to beds in German intensive care units (defined as within an arm’s length of the patient) was adhered to in only 73.5% of cases. In normal care wards, the required equipment was only implemented in 31.5% of cases [11].

Meanwhile, the KRINKO has also published new recommendations for the installation of hand disinfectant dispensers [8]. They are as follows:

- › Disinfectant dispensers are to be located in close proximity wherever hand disinfection has to be carried out [Cat. JB, JV].
- › For patient rooms, depending on the number of beds, one dispenser per patient bed on dialysis and intensive care units and one dispenser for every two patient beds on non-intensive wards as well as in the sanitary cell is recommended as a minimum.
- › The type of dispenser deployed, i.e. wall or bed-mounted dispensers, mobile dispensers with dosing pumps or lab coat bottles, depends on the spatial conditions and the patients to be cared for. For example, in geriatric, psychiatric and paediatric wards as well inpatient care facilities and outpatient services, it may make sense to rely on lab coat bottles and dispensers on ward or dressing trolleys in order to exclude hazards for patients from the disinfectant.

National and international approaches to single rooms and to the room sizes

Although most infectious pathogens, including multiresistant pathogens, are not transmitted by air but via contact, single room accommodation demonstrated a protective effect according to our systematic review for intensive care patients. From the point of view of infection prevention, it is probably useful if a nurse or a doctor can concentrate on working on one patient in a room and is not distracted by the patient in the adjacent bed (possibly also combined with manipulations to the adjacent patient without disinfecting hands in between). According to the results of our survey in German hospitals in 2015 (see also the chapter entitled “Survey on the Constructional Structure of Hospitals in Germany” in the appendix starting on page 54), the majority of patients is still accommodated in two-bed rooms (57.1%). In intensive care units, 27.1% of beds are located in single-bed rooms and the remaining beds are in larger multi-bed rooms. In normal care wards, almost half of beds are in two-bed rooms (48.3%). Only 6.4% of beds are in single-bed rooms [11].

The KRINKO also recommends that at least 40% or better 50% of rooms for isolation for the medical care of patients with reduced immune reactions be planned as single rooms [12], [13]. These single rooms are to be implemented with their own bath and toilet with appropriate hand disinfectant dispensers and an adequately large entrance area.

The KRINKO did not, however, explicitly specify single-bed room equipment. They merely stated that single-bed room accommodation is necessary if transmission of the pathogen can occur by air (airborne infection) or via respiratory secretions (droplet infection) [14]. In addition, they state that the recommendation for single-bed accommodation can also be based on the distinctiveness of individual diseases or individual disease phases (profuse diarrhoea), transmission routes which are hard to control (e.g. ectoparasites) or with patients who are not able to comply with basic hygiene measures. Additionally, they recommend that with new planning or renovation of normal care wards, beds in single rooms should not constitute more than 10 to 20% of the total number of beds. The precise number of single-bed rooms required should be defined on a departmental level by the medical directors and the hospital administration in collaboration with the responsible hospital hygienist (or the hygiene commission) and thus be adjusted to actual needs.

The German Interdisciplinary Association for Intensive Care and Emergency Medicine (Deutsche Interdisziplinäre Vereinigung für Intensiv- und Notfallmedizin – DIVI) provides extremely specific requirements for intensive care units. It advises equipping them exclusively with single-bed rooms 20 m² in size, with airlocks, and 40 m² two-bed rooms. An intensive care unit should have at least one isolation room for every six beds in an intensive care unit [15].

Internationally, many other countries have already progressed much further with regard to the implementation of single-bed rooms. The British National Health Service demands a 50% share of single rooms for new medical facilities [16]. In Scotland, there are calls for a 100% share of single-bed rooms in hospitals, whilst the French ministry of health favours single-bed rooms but has not so far issued any specific requirements [17]. Hospitals with 100% single room accommodation already exist in Norway and the Netherlands.

In their investigation, published in 2015, Maben et al. assessed that a hospital equipped with 100% single-bed rooms rather than just 50% meant 5% higher building costs [18]. Higher operating costs were caused mainly by the additional cleaning due to the greater number of single-bed rooms [19].

Summarising remarks

There are currently few studies which prove a connection between constructional factors in hospitals and the occurrence of hospital infections or the acquisition of multiresistant pathogens.

It has been proven that improvements in hand hygiene have been achieved through the adequate equipment of patient rooms with hand disinfectant dispensers close to beds. Intensive care units should be equipped with at least one hand disinfectant dispenser per patient bed. In normal care wards, the minimum equipment should be one dispenser for every two patient beds and in the sanitary cell.

Evidence of the benefits of equipping the intensive care unit with as many single-bed rooms as possible is also relatively good. For this reason, significantly more single rooms should be built in intensive care units in future, possibly 100%.

The present state of studies with regard to the installation of single rooms in normal care wards is less good, and appropriate recommendations can best be derived from conclusions by analogy. According to KRINKO recommendations, a proportion of at least 20 to 30% of the total number of beds in a hospital should be in single rooms in order to be able to at least better accommodate patients with infections or multiresistant pathogens. We are still a long way away from this standard. In many other West European countries and the USA, there are already requirements for a significantly higher percentage of single-bed rooms for normal care wards. A 50% share of single rooms should be discussed.

The relevant literature provides little information as to the necessary size of patient rooms. The room size results mainly from the surface areas necessary to implement care and therapy measures.

Laws, standards and guidelines

Overview of laws and standards for planning

In the field of hygiene, requirements for statutory provisions and recommendations for action are high. This is because measures to prevent infection are not always complied with due to the uncertainties prevalent in day-to-day life, existing gaps in knowledge, reluctance to accept advice or a lack of motivation by hospital workers. Various regulations exist to avoid or reduce nosocomial infections. In the following, major infection prevention standards in the context of functional building requirements are illustrated in a structured manner and classified according to their significance in statutory regulations, ordinances and the regulations of private organisations.

Fig 12:
Level of detail and number of laws,
ordinances and regulations

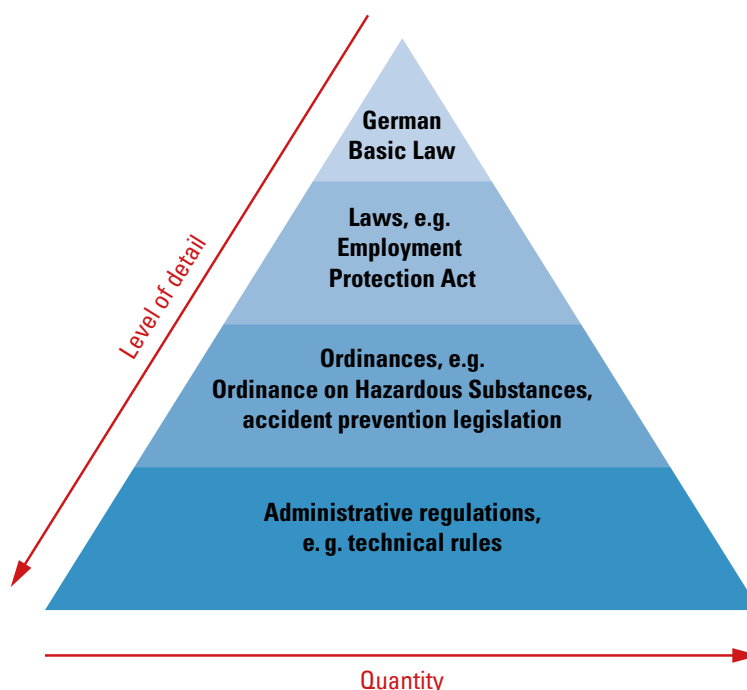

Top image:
Source: DeStagge/AdobeStock

The **German Infection Protection Act (Deutsches Infektionsschutzgesetz - IfSG)** has been in force since 1st January 2001. It regulates the prevention and combating of infectious diseases in humans. The central significance of the law consists of the preventive measures for transmitting diseases to humans, the fast identification of infections and the avoidance of them spreading further. The IfSG also states that the Commission for Hospital Hygiene and Infection Prevention (KRINKO) has been set up at the Robert Koch Institute. [20]

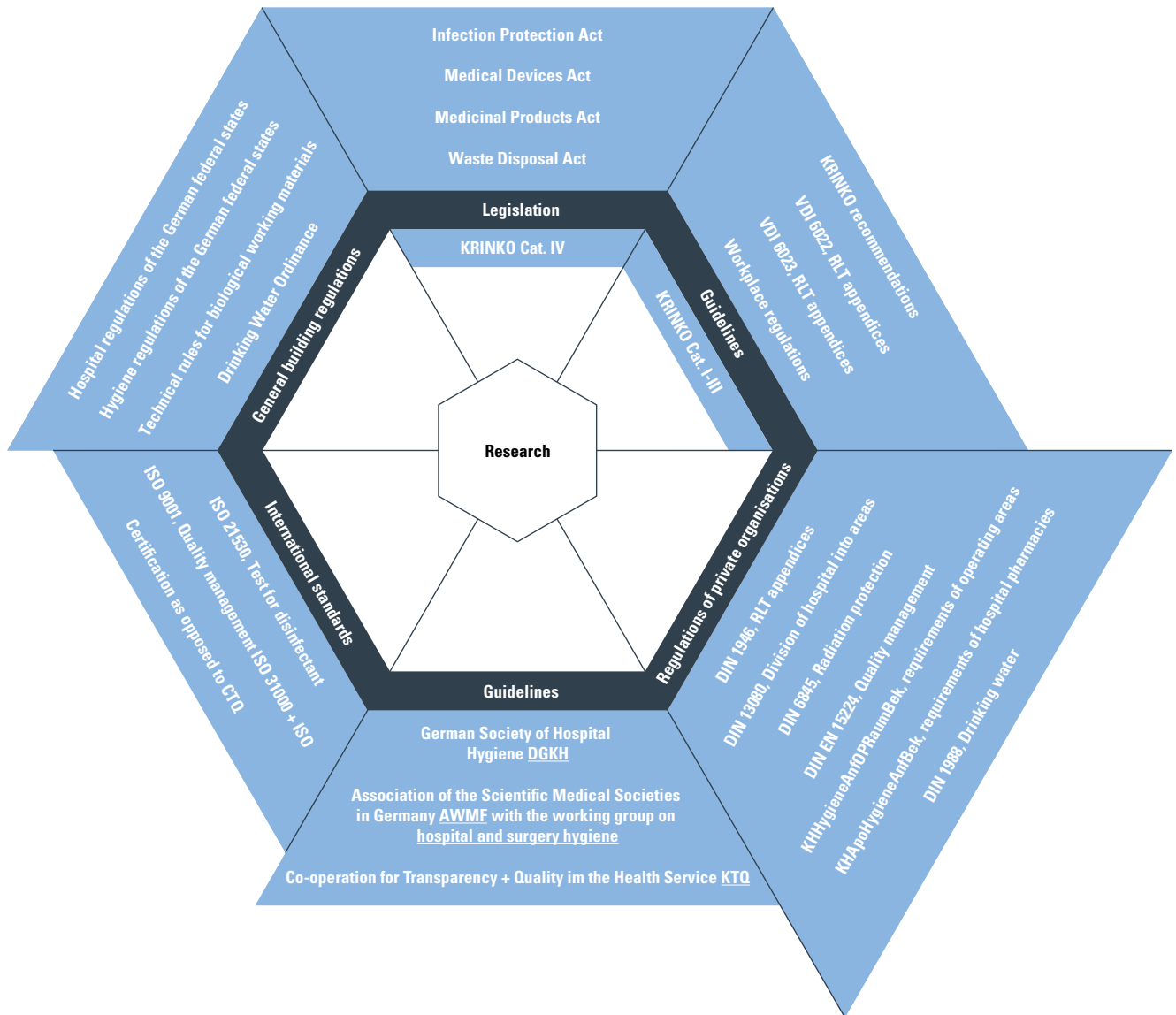

Fig 13: Overview of laws, ordinances and regulations. Specifications concerning building are marked in red.

This KRINKO continuously publishes recommendations on hygiene-relevant topics such as the cleaning and disinfecting of surfaces, dealing with multiresistant germs or the organisation of functional areas. In some parts, recommendations on the structural and functional design of a hospital are given, such as space requirements, room size and the location of hygiene-relevant rooms as well as the quality of the materials to be used. Those KRINKO recommendations which concern structural and functional aspects apply primarily to the areas of endoscopy, the central sterile equipment department, the isolation ward, operating theatre, neonatology, oncology and the intensive care unit (ICU). Due to amendment of the IfSG of 28th July 2011, all medical facilities are obliged to take note of KRINKO recommendations. Based on scientific studies and theoretical reasons, the commission has developed a categorisation of their individual recommendations in order to guarantee the implementation of hygiene guidelines. [21]

Further hygiene-relevant laws:

Medical Devices Act (Medizinproduktegesetz) [22], Medicinal Products Act (Arzneimittelgesetz) [23], Recycling Management and Waste Act (Kreislaufwirtschaftsgesetz) [24]

At the level of ordinances, the building regulations, the hospital ordinances of various federal states, the Drinking Water Ordinance and also the Fee Structure for Architects and Engineers (Honorarordnung für Architekten und Ingenieure - HOAI) should be mentioned in relation to functional building requirements. Apart from the general building regulations, six federal states (Brandenburg, Berlin, North Rhine-Westphalia, Saarland, Saxony-Anhalt and Schleswig-Holstein) have passed ordinances which concern the specific requirements of hospitals.

In addition, there is the Model Hospital Building Regulation of 1976 (Krankenhausbauverordnung - KhBauVO) which sets out guidelines for fire protection, hygiene, ventilation and lighting as well as room size and layout. The changing requirements for the construction and operation of health buildings over the years mean that the Model Hospital Building Regulation is no longer up to date and urgently needs revising. Nevertheless, the Model Hospital Building Regulation is still used by many planners as a guide. [25]

There are a number of guidelines and recommendations from private organisations which supplement laws and ordinances and which are put up by expert committees and give concrete instructions for action in the field of hygiene. They are rules which have been recognised by science as being theoretically correct, are consistently known in practice by technicians trained to state of the art and which have proven themselves through sustained practical experience.

DIN-norms: For the construction of hospitals, the German Industrial Norm (Deutsche Industrienorm - DIN) DIN 13080 specifies the subdivision of the hospital into functional areas and functional locations as well as the structuring of areas according to hospital-relevant functions. [26] A further standard which is relevant for hospitals is DIN 1946-4, which concerns room ventilation and air conditioning in hospital buildings and rooms. [27]

VDI guidelines: The Association of German Engineers (Verein Deutscher Ingenieure – VDI) has published VDI Guideline 6023, “Hygiene in Drinking Water Installations” and VDI Guideline 6022, “Room Ventilation Technology and Room Air Quality”. Furthermore, since 2013 there has been an expert committee on the topic of sustainability in the construction and operation of hospitals, which deals, among other things, with the topic of hygiene. [28, 29]

DIVI: The German Interdisciplinary Association for Intensive Care and Emergency Medicine is a consortium of persons and scientific and professional associations with the aim of promoting intensive care medicine. Accordingly, it has published the “Recommendation on the Structure and Equipment of Intensive Therapy Wards”. [30]

State Offices: The state offices of various federal states publish information sheets on infection and hygiene-related requirements. In 2016, the Mecklenburg-Western Pomeranian State Office for Health and Social Affairs (Landesamt für Gesundheit und Soziales - LAGuS) published the information sheet "Construction Requirements and Functional Recommendations with Regard to Hygiene" [31]; in 2014, the Bavarian State Office for Health and Food Safety (Landesamt für Gesundheit und Lebensmittelsicherheit - LGL) published the modular guideline "Explanations for the Check List for the Care of Immunocompromised Patients" [32]

Conference of Construction Ministers Expert Commission on Construction and Cost Planning: The Conference of Construction Ministers calls for project groups on hospital-relevant functional positions at regular intervals. The task of the respective project groups is the development of a practice-oriented planning guide, which issues recommendations on constructional, structural and technical requirements in state and subsidised hospital construction in terms of concepts, standards and qualities, one of which is the "Intensive Care Planning Guide" of the Hospital Construction Network from 2018. [33]



General recommendations

The planning recommendations set out here are based on the investigations carried out in the “HYBAU+” research project in the disciplines of building, materials and hygiene.

With these recommendations, new or re-planned building structures can be designed in such a manner that they can have a sustained preventive effect on infections amongst patients and hospital staff. For this, the potentials of individual aspects of ward structure, rooms and possibly further details are set out which can be adapted to the overall orientation of the respective hospital. The following recommendations do not include the areas of technical building equipment such as the drinking water installation or ventilation system technology since their thematic focus is placed on structural (surfaces, materials and furniture) and functional (process) components. Every hospital must determine and observe its own organisational and financial framework conditions. The remarks on planning building structures are therefore concerned neither with specific medical specialisations nor with the proportion of different patients.

The given recommendations aim to support medical and nursing staff in their day-to-day procedures in a hygienic environment. This is supported by building structures which strengthen spatial orientation and clarity, which reduce distances between hygiene-relevant rooms or which can react flexibly to changes.

These recommendations for action are to be regarded as an initial step in the direction of building structures which prevent infection. They represent only one component of a group of necessary measures. Further research into this topic is needed in future.

Due to the differing functional, technical and staff requirements, the constructional and process-related recommendations for action for the operating area, the emergency department and the intensive care unit are set out in three separate chapters. Material-specific requirements complete each respective area. In addition, general recommendations can also be made which can be applied to all hygiene-relevant areas of a hospital. The design principles (system recommendations for the floor plan), which can serve as a prerequisite for the purposeful, specific design of these areas, are defined below.

Top image:

Source: VILevi/AdobeStock

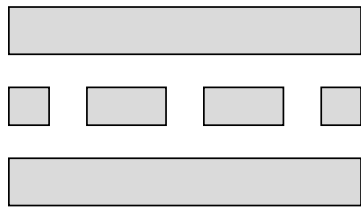

Exemplary structure e.g. for normal and intensive care, operating theatre, central emergency department

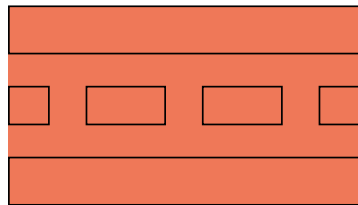

Jointless surfaces

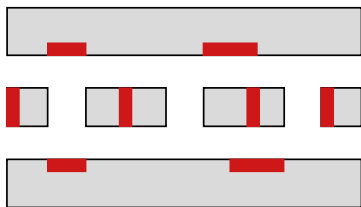

Adequate, decentralised storage

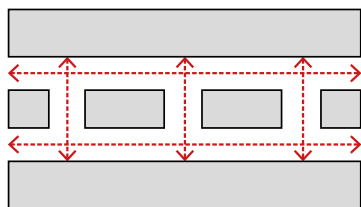

Short routes inside areas

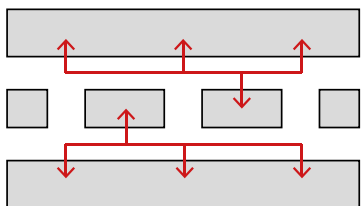

Permit optimised processes

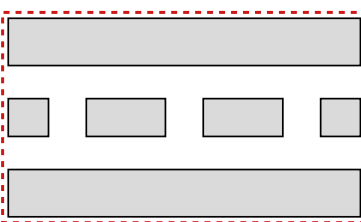

Functionally optimised layout structure, compactness

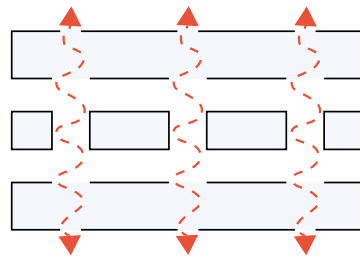

Natural ventilation

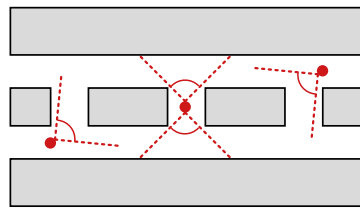

Good clarity

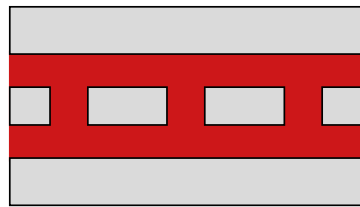

Adequate movement area

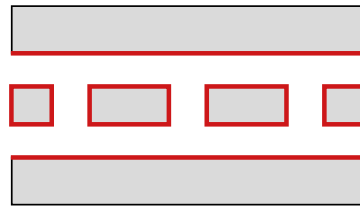

No projecting edges and recesses

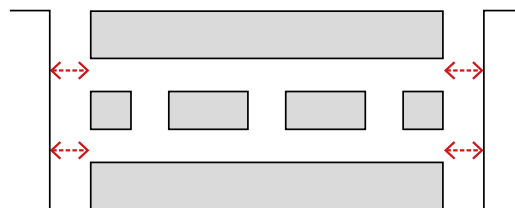

Short routes to adjacent hygiene-relevant functional areas

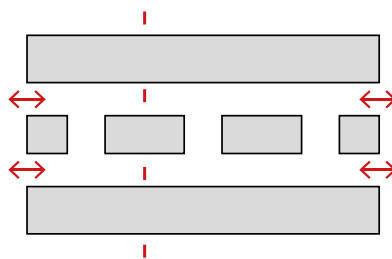

Permit temporary separability

Fig 14:
System recommendations for the floor plan

a1

Rooms without supports as far as possible
in hygiene-relevant and intensive treatment
areas such as e.g. shock and
intervention rooms

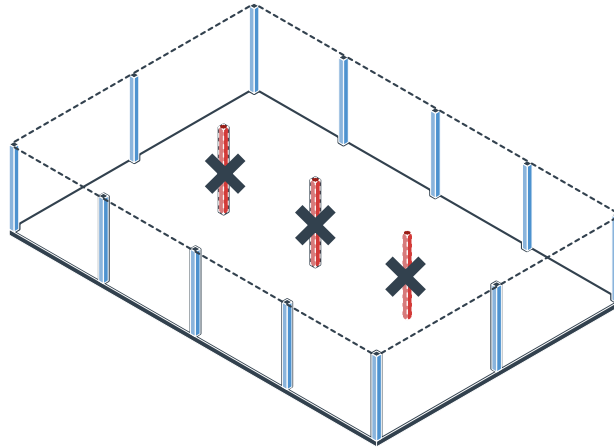

a2

Fewer projecting edges and recesses for
simpler and faster cleaning

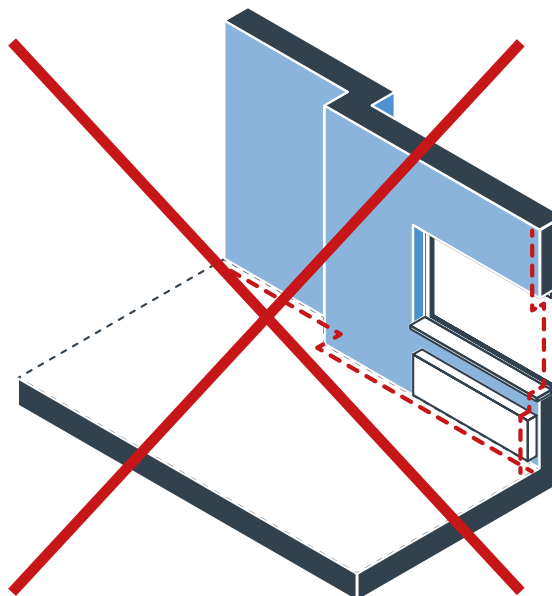
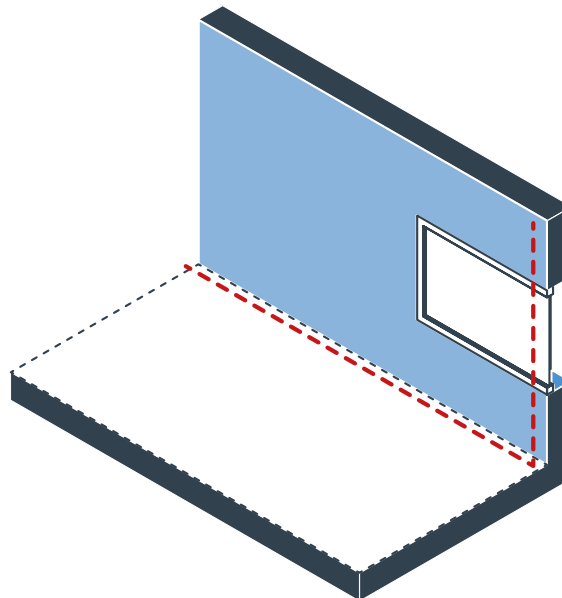

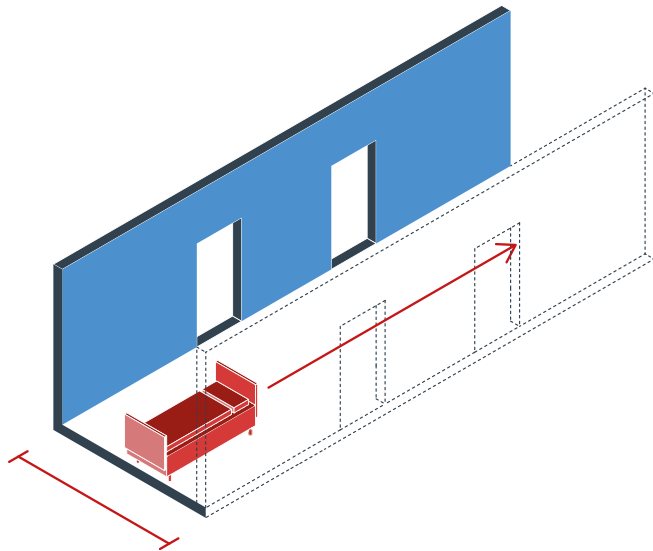

a3

Optimise traffic areas adequately for care processes

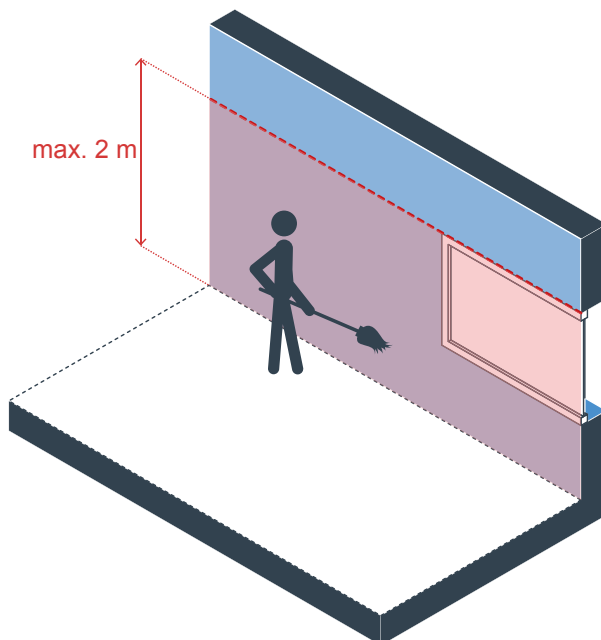
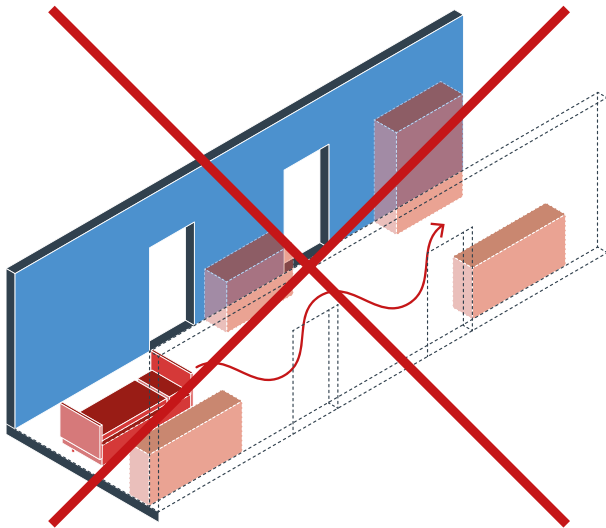

a4

No projecting edges and recesses above a height of 2m as they are rarely cleaned

a5

Sufficient storage and work space in care and treatment-intensive areas

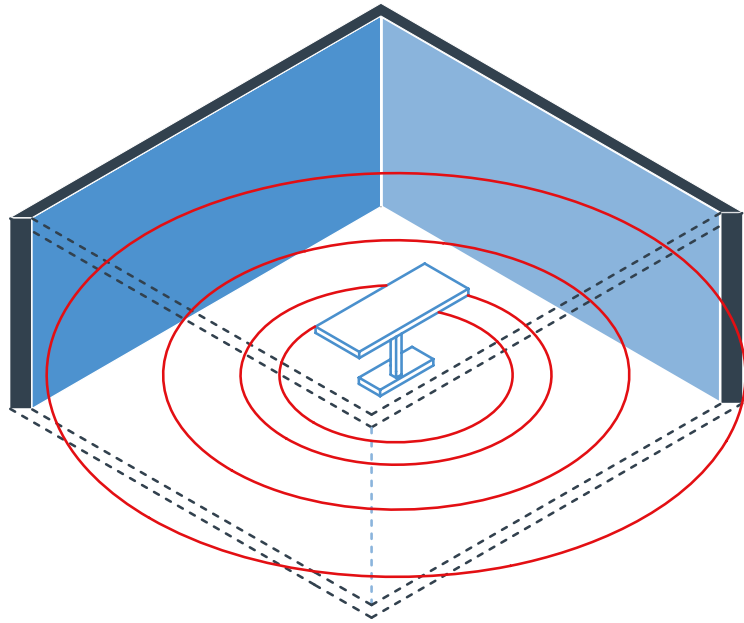

a6

As far as possible, separate lifts for patient beds and visitors

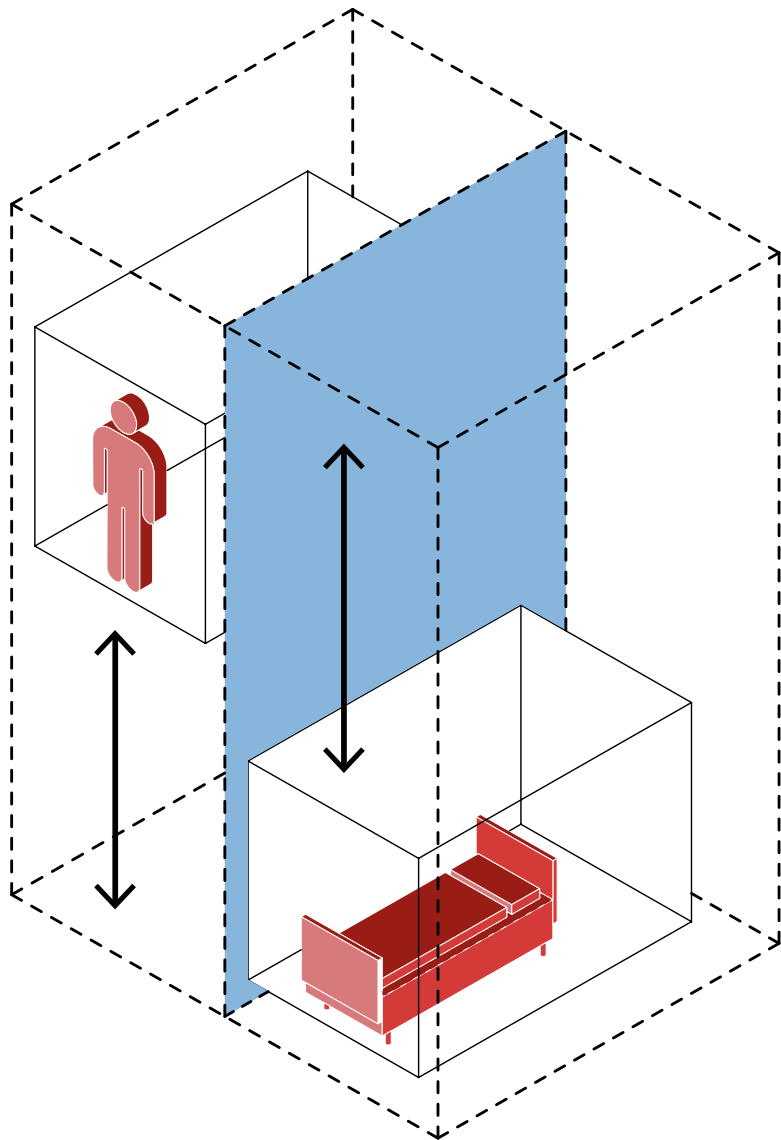

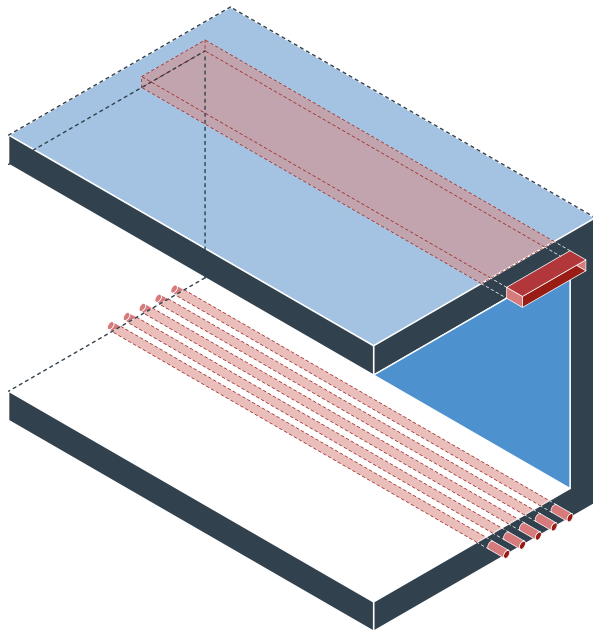

a7

Integrate cables, shafts and heating elements into walls and ceilings/floors

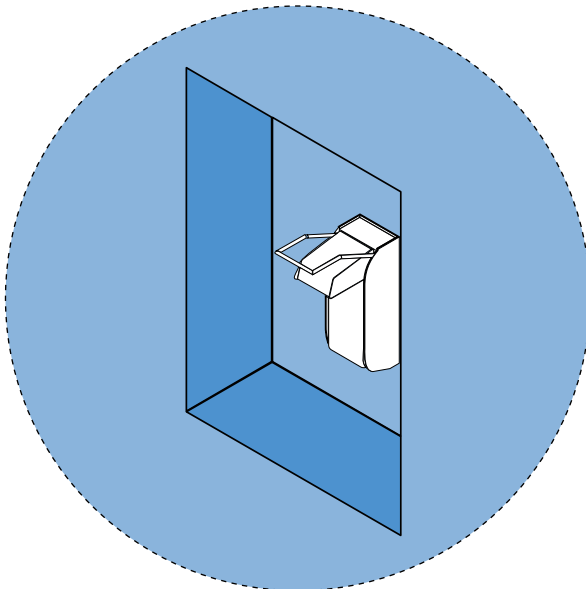

a8

Integrate disinfectant dispensers visibly into protected wall niches

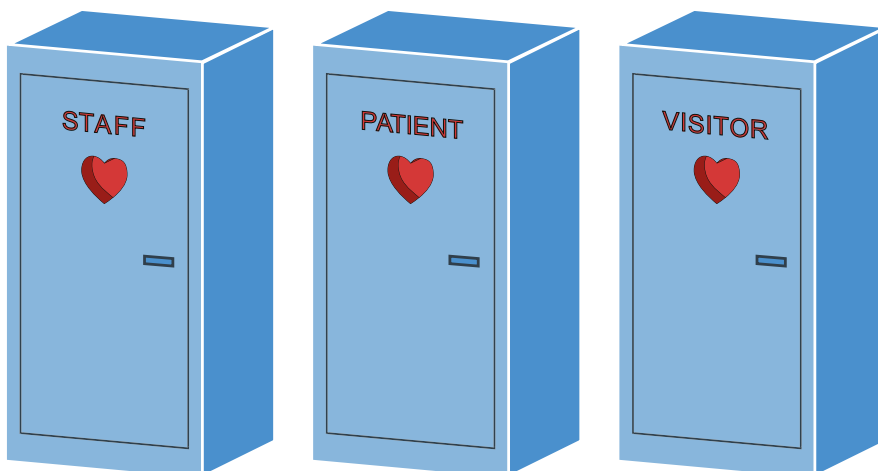

a9

Plan separate toilet facilities for different user groups

A close-up photograph showing a person's hand using a blue cloth to clean a white, curved surface, likely a piece of medical equipment or a wall panel. The background is a light-colored, possibly marble, floor. The text 'Materials in general' is overlaid in large, bold, white letters with a black drop shadow.

Materials in general

Nosocomial infections can be prevented at various levels. The structural requirements of hygiene-safe materials have not been pushed a great deal so far. This publication demonstrates that a hospital as a healthcare facility can be hygienically optimised with regard to material and technical aspects.

Due to the many usage profiles for the rooms in a hospital, building components and materials must conform to widely differing mechanical, physical, chemical and hygienic requirements.

The technical requirements of the levels with which the user comes into direct or indirect contact are therefore defined at building component level. Floor, wall and ceiling coverings and also items of equipment are of direct interest in this case. Greatly differing building component requirements are to be expected in various functional sections so that these are differentiated in the following areas. In doing so the hygiene-critical functional sections are looked at in more detail.

Top image:

Source: akf/AdobeStock

General requirements of materials in the hygiene area

Mechanical:



Impact-resistant

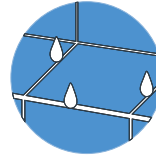

Sealed joints

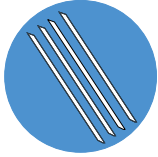

Scratch-proof



Non-slip



Abrasion-resistant

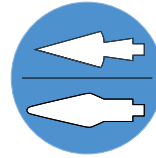

Wear-resistant

Chemical:



Acid/alkali-resistant

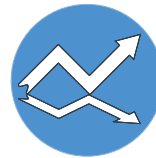

Non-reflecting



Solvent-resistant



Water vapour-resistant



Oil/grease-resistant



Liquid-tight



Corrosion-resistant

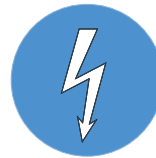

Electrically conductive

Hygienic:



Disinfectant-resistant



Easy to clean



Operating area

Operating areas are complex facilities in terms of function, organisation and processes; many processes run simultaneously. Concepts for operating areas are decisively determined by considerations of capacities, cost-effectiveness, hygienic aspects, separation of traffic and technical solutions, especially in relation to ventilation and air conditioning technology in the operating theatre and in the adjacent rooms. Functions upstream and downstream of the operating theatre such as holding functions, anaesthetisation and recovery functions are the subject of differing solution approaches.

Whilst originally decentralised – i.e. medically specialised – operating areas were planned, nowadays new construction projects almost universally implement central operating areas. Decentralisation of the complicated technology and staff resources is not economically justifiable.

The functionality of operating areas is decisively influenced by the pure or impure (i.e. contaminated) flow of goods. The optimum provision of sterile equipment is especially important. Different logistical solutions are conceivable here. They should be provided via a central sterile equipment department (CSED) in close proximity to the central operating area.

With regard to room configuration, the operating area has an airlock/decontamination zone upstream which separates the hygienically important internal area from the rest of the hospital. This zone has a holding area for patients, staff changing cubicles, decontamination airlocks for patients and goods, control centres, etc.

A major part of operating areas is the operating unit, defined as an operating theatre with associated ancillary rooms. The main focus is on the work processes at the operating table, where all functions come together with precise co-ordination.

Outside the operating area but directly adjacent to the airlock zone there is a central recovery area in which patients not placed in intensive care are cared for as they recover from their operations.

Top image:

Source: gpointstudio/AdobeStock

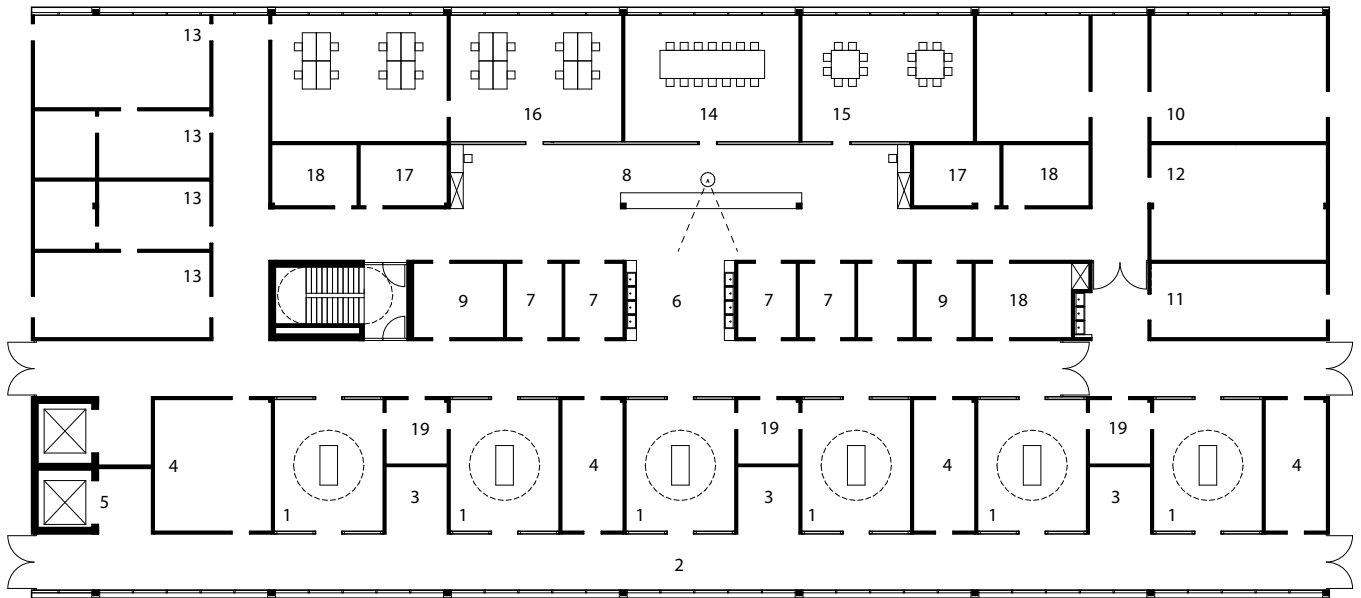

Fig. 15

Diagrammatic ground plan

Operating area

- 1 Operating theatre
- 2 Sterile corridor
- 3 Preparation
- 4 Equipment room
- 5 Sterile equipment department

- 6 Washing
- 7 Induction room
- 8 Support point
- 9 Medical material
- 10 Patient airlock A
- 11 Patient airlock B
- 12 Transporters
- 13 Staff changing room/WC

- 14 Meeting room
- 15 Staff room
- 16 Office
- 17 Dictation
- 18 Store
- 19 Disposal

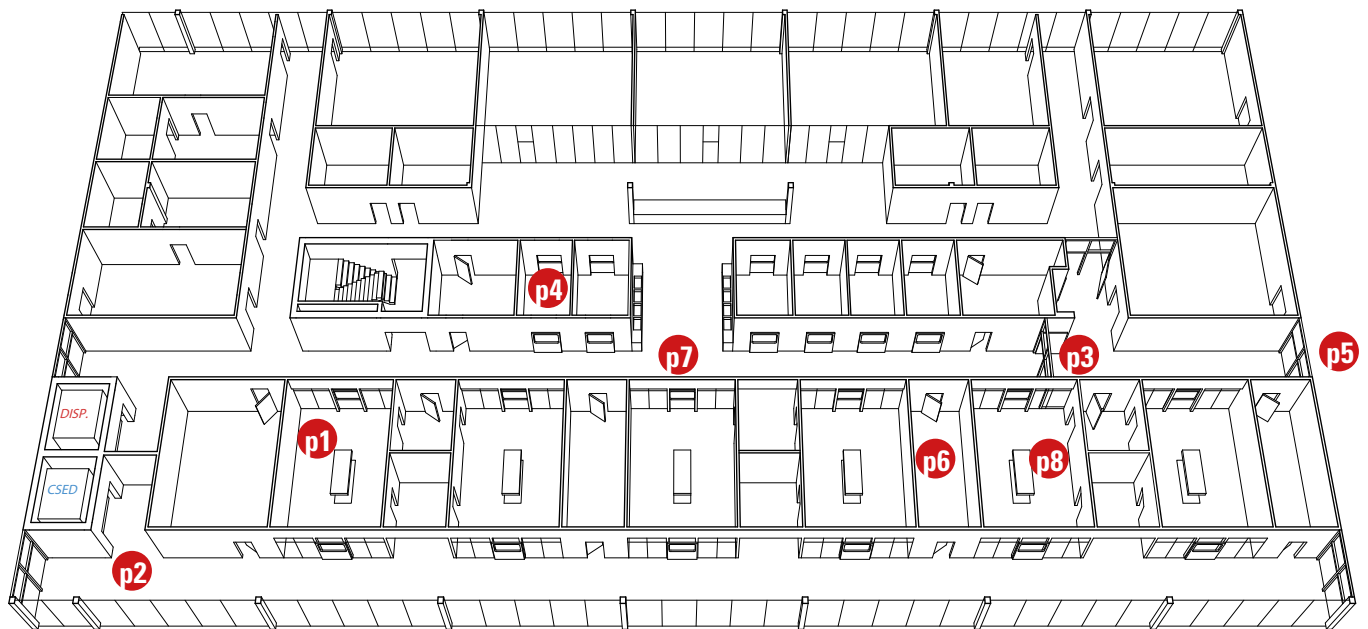
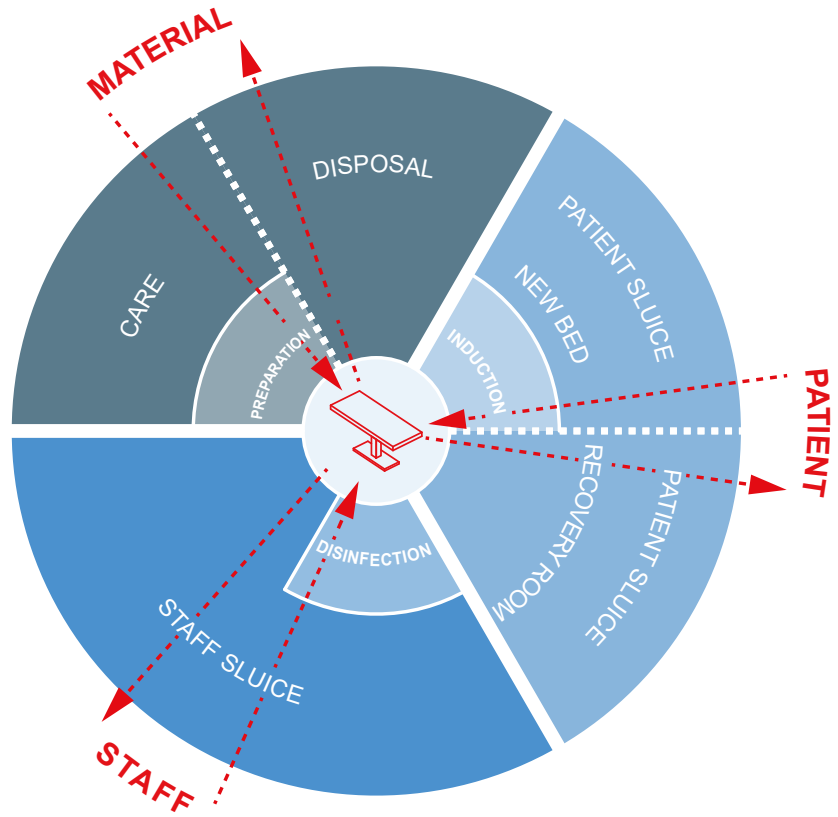

Fig. 16

Planning recommendations for the operating area

- p1 Procedures for materials/patients/staff
- p2 Sterile equipment layout
- p3 Temporarily lockable
- p4 Distance from induction room to operating theatre

- p5 Shortcut from operating theatre to recovery room
- p6 Medical equipment
- p7 Viewing windows in doors
- p8 Daylight



p1

Hygiene relevance grading

Patient, staff and material processes separate as far as possible, taking special account of hygiene-relevant grading

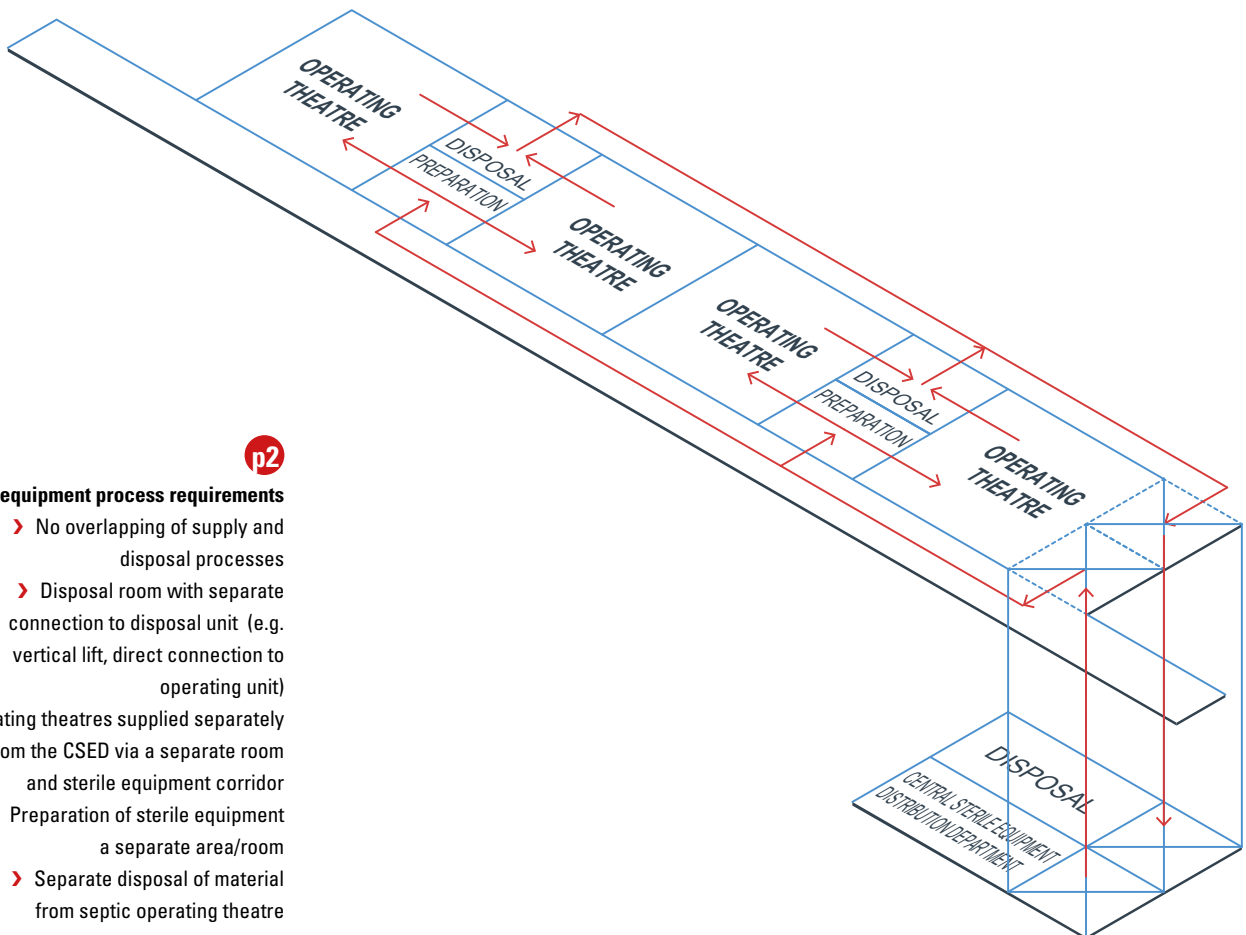

p2

Sterile equipment process requirements

- > No overlapping of supply and disposal processes
- > Disposal room with separate connection to disposal unit (e.g. vertical lift, direct connection to operating unit)
- > Operating theatres supplied separately from the CSED via a separate room and sterile equipment corridor
- > Preparation of sterile equipment a separate area/room
- > Separate disposal of material from septic operating theatre

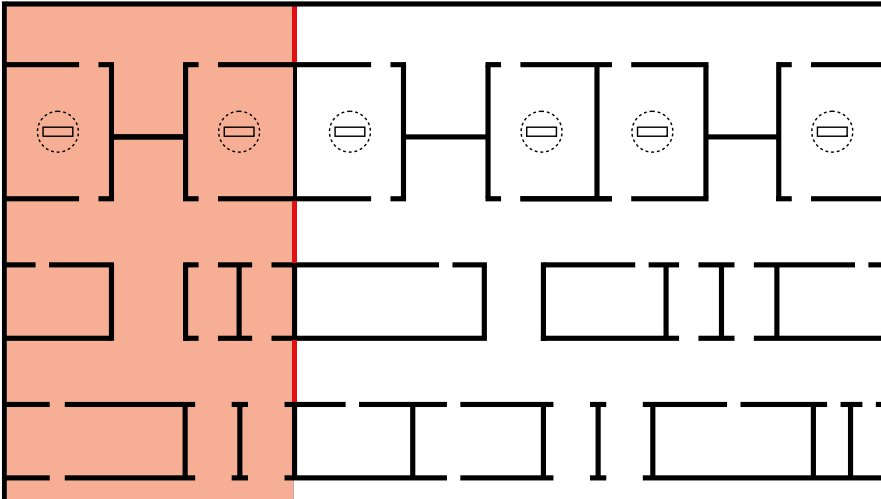

p3

Temporary separability of houses with a very heterogeneous operating spectrum/ isolation for a specific operating spectrum

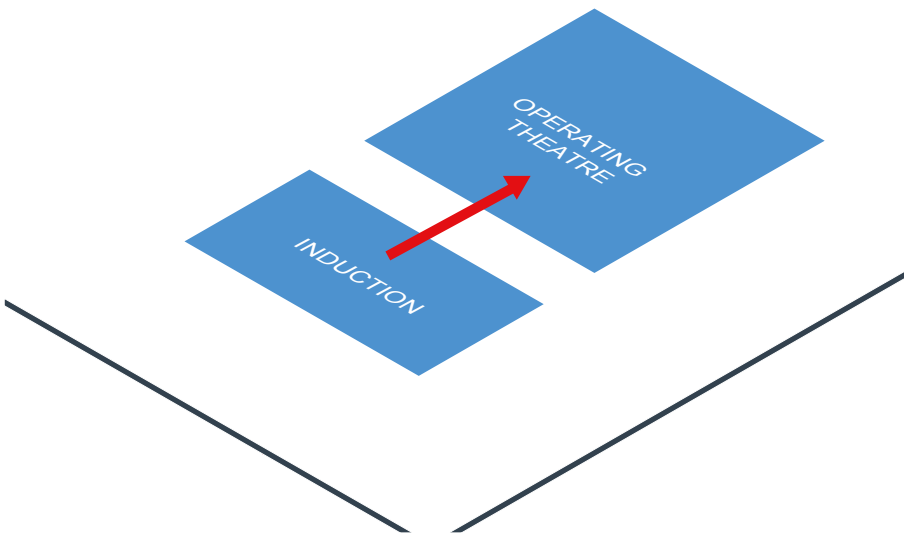

p4

Not too great a distance from induction room to operating theatre/ field

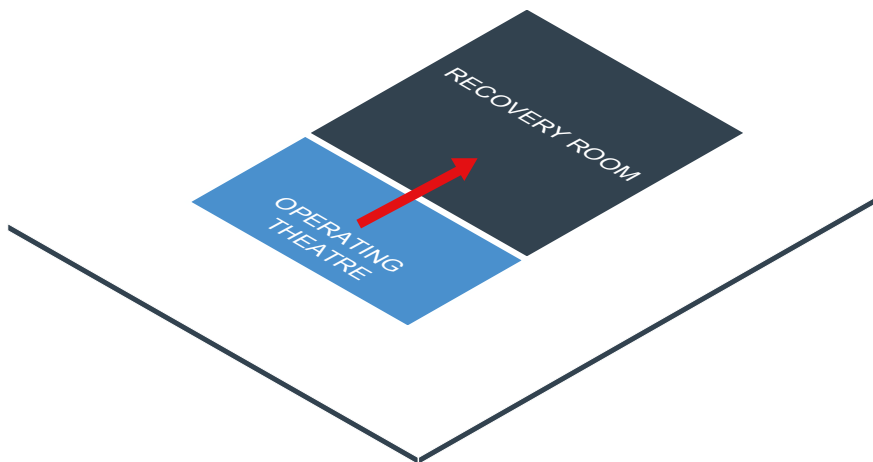

p5

Shortcut from operating theatre to recovery room

- p6**
- > Technical medical equipment to the floor with as little contact as possible
 - > Permanently installed equipment installed from the ceiling as far as possible
 - > Only essential equipment to be kept in the operating theatre
 - > Plan external storage areas nearby

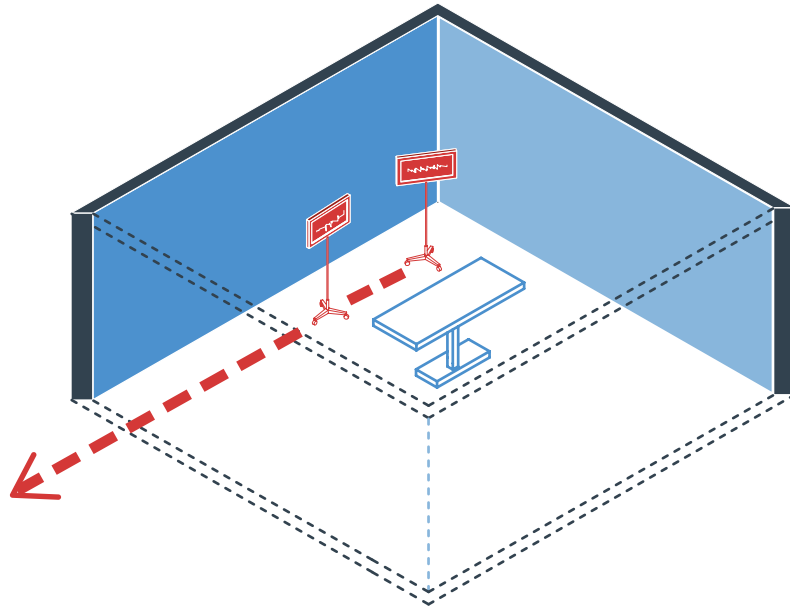

- p7**
- > Set up doors with viewing windows for checking and communication

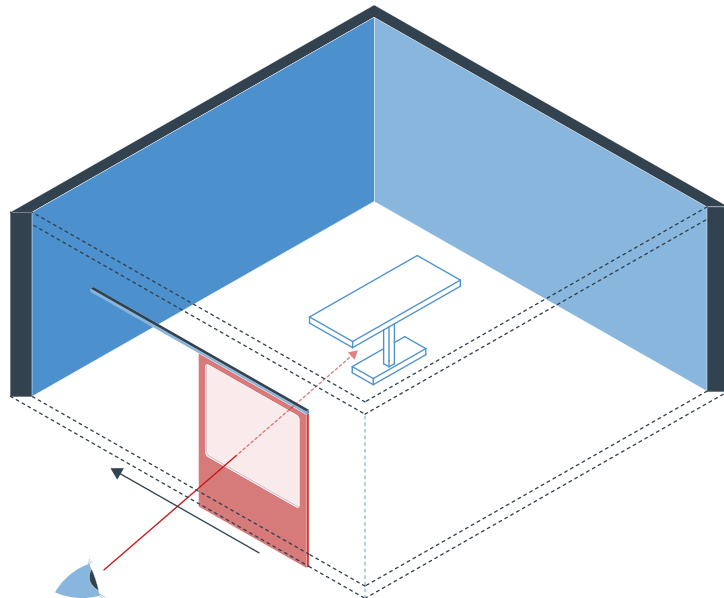

- p8**
- > Design intensive treatment rooms (such as the operating theatre) with connection to external areas (windows)

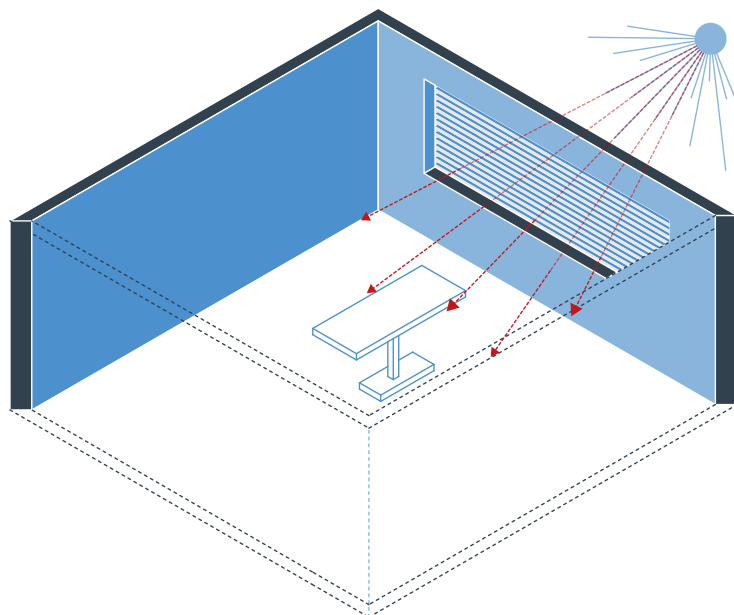

























Table 2: Materials

Mechanical requirements	Floor	Wall	Ceiling
Impact-resistant			
Scratch-proof			
Abrasion-resistant			
Sealed joints			
Non-slip			
Wear-resistant			
Chemical/physical requirements			
Acid/alkali-resistant			
Solvent-resistant			
Oil/grease-resistant			
Corrosion-resistant			
Non-reflecting			
Water vapour-resistant			
Liquid-tight			
Electrically conductive			
Hygiene requirements			
Disinfectant-proof			
Easy to clean			

Material recommendation	Floor	Wall	Ceiling
Operating area	<ul style="list-style-type: none"> › (Matt) acrylic paints, coatings with interspersed conductive particles on a suitable subsurface › Polyolefins › Rubber › PVC › Ceramic tiles/stoneware with coated joints › Linoleum › Terrazzo 	<ul style="list-style-type: none"> › Emulsion paint › Varnish › Oils on subsurfaces with ramming protection fitted › Woodchip › Glass fibre fabric mesh tape with latex coating › Metals (e.g. stainless steel, anodised aluminium, copper alloys, enamelled steels) › Polyolefins › Rubber › PVC 	<ul style="list-style-type: none"> › Emulsion paint › Varnish › Woodchip › Glass fibre fabric mesh tape with latex coating › Metals (e.g. stainless steel, anodised aluminium, copper alloys, enamelled steels)



Central emergency department (A&E)

A hospital's emergency department is the central point of contact for emergency patients. Emergency patients include those patients who are at imminent risk as a result of falling ill, being injured, poisoned or for other reasons and whose vital functions are significantly impaired.

The medical control process and the effectiveness of the medical organisation are decisively influenced by the emergency department. It is imperative that all facilities, functions and equipment necessary for primary diagnosis and initial treatment are directly to hand in the emergency department.

The emergency department is often characterised by complex processes in which the interaction of staff and the co-ordination of processes are vital. The arrangement of waiting areas, emergency rooms and repositioning areas for patients must be carefully planned for acute care. It is essential that the emergency department be connected to an emergency operating area.

Patient groups which pass through emergency can only be separated from one another to a limited degree within processes. Many emergency patients, for example, leave hospital after initial care and are called back as outpatients for follow-up care (basic diagnostics). At the beginning at least, the diagnostic processes are often identical for both emergency patients and outpatients.

Optimum hygiene management in the emergency department is important due to initial contact with patients. This includes both the detection of verified and potential infectious diseases in close collaboration with emergency services and also MRP screening according to risk profile and risk assessment during the patient's stay in the emergency department.

Top image:

Source: gpointstudio/AdobeStock

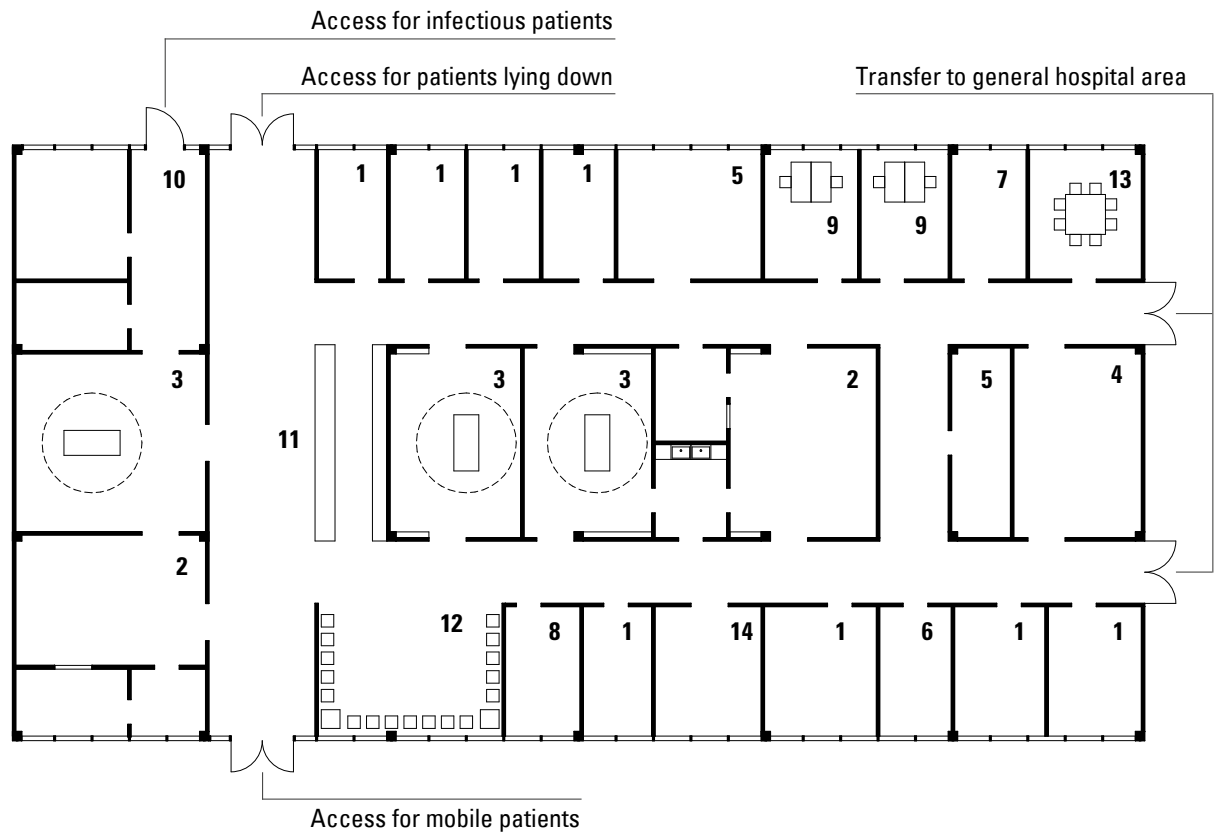

Fig 17:

Diagrammatic floor plan of an emergency room

- | | | |
|-----------------------------|------------------------|--------------------------------|
| 1 Examination and treatment | 3 Shock room | 9 Office |
| 2 X-ray | 4 Plaster room | 10 Patient airlock, infections |
| | 5 Equipment/stretchers | 11 Triage/Support point |
| | 6 Store | 12 Waiting area |
| | 7 WC, staff | 13 Staff room |
| | 8 WC, patient | 14 Wound treatment |



Fig 18:

Central emergency department (A&E) planning recommendation

- | | |
|----------------------------|----------------------|
| z1 Functional schema | z4 Triage overview |
| z2 Separate infrastructure | a9 Separated toilets |
| z3 Patient flow | |

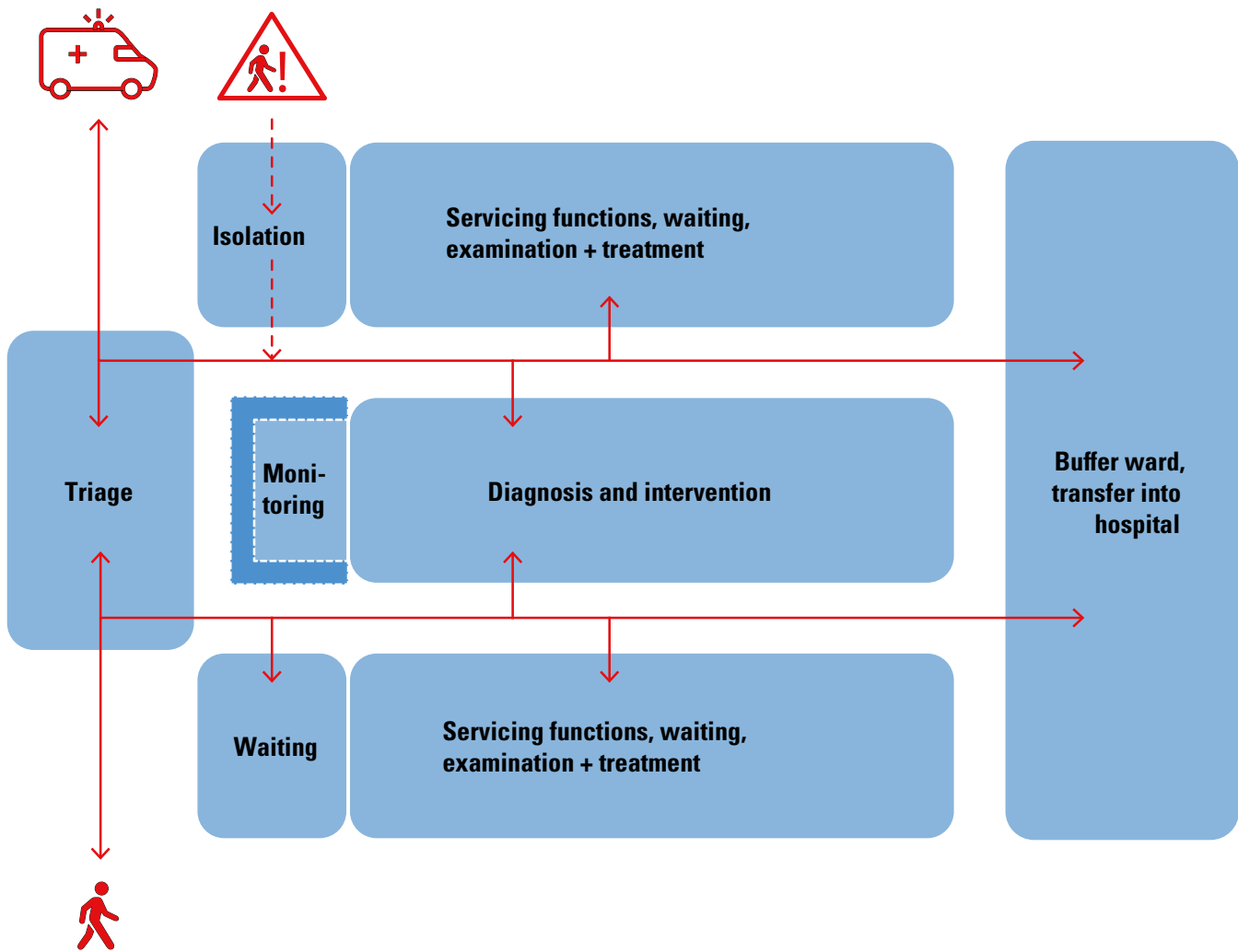

z1
Functional schema

Overview of the central emergency department (A&E) planning recommendation

- › Separate access from outpatient to inpatient (ambulance), on foot (mostly in the vicinity of the hospital's main entrance) and critical infection cases
- › One central triage for these three access routes
- › Transfer of patients on the premises via a buffer ward (intermediate care (IMC))
- › Spatial separation of the ward into immobile patients lying down and mobile patients
- › Organise diagnosis and intervention area (shock room, computer tomography (CT) etc.) as a central strand between them
- › Organise waiting, examination and treatment areas as well as serving functions radially or in parallel strands to the central area

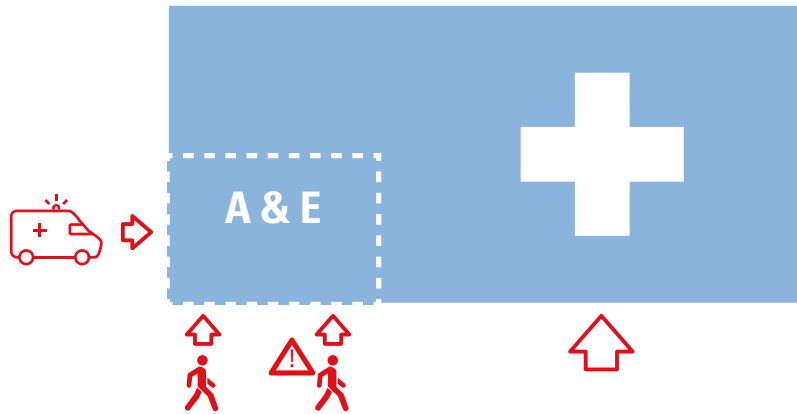

z2

Separate infrastructure

Guarantee clear and visible separation of access routes for the central emergency department and the main entrance



z3

Patient flow

Include optimum patient flow in planning

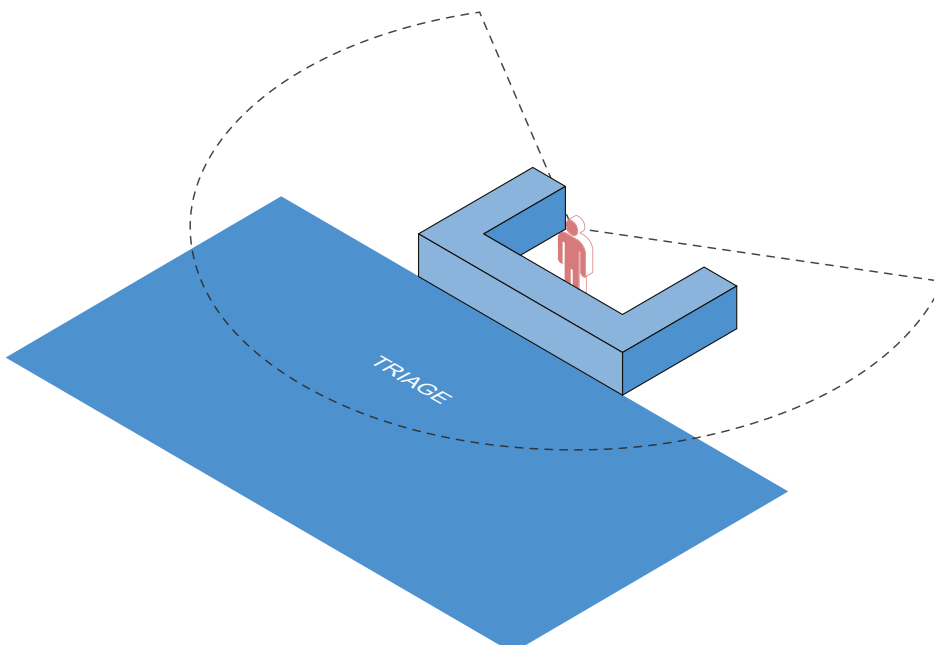























z4

Overview in triage

Organise triage centrally to monitor spatial processes

Table 3: Materials

Mechanical requirements	Floor	Wall	Ceiling
Impact-resistant			
Scratch-proof			
Abrasion-resistant			
Sealed joints			
Non-slip			
Wear-resistant			
Chemical/physical requirements			
Acid/alkali-resistant			
Solvent-resistant			
Oil/grease-resistant			
Corrosion-resistant			
Non-reflecting			
Water vapour-resistant			
Liquid-tight			
Electrically conductive			
Hygiene requirements			
Disinfectant-proof			
Easy to clean			

Material recommendation	Floor	Wall	Ceiling
Central emergency department (A&E)	<ul style="list-style-type: none"> > (Matt) acrylic paints, coatings with interspersed conductive particles on a suitable subsurface > Polyolefins > Rubber > PVC > Ceramic tiles/stoneware with coated joints > Linoleum > Terrazzo 	<ul style="list-style-type: none"> > Emulsion paint > Varnish > Oils on subsurfaces with ramming protection fitted > Woodchip > Glass fibre fabric mesh tape with latex coating > Metals (e.g. stainless steel, anodised aluminium, copper alloys, enamelled steels) > Polyolefins > Rubber > PVC 	<ul style="list-style-type: none"> > Emulsion paint > Varnish > Woodchip > Glass fibre fabric mesh tape with latex coating > Metals (e.g. stainless steel, anodised aluminium, copper alloys, enamelled steels)

Right-hand image:
Source: edwardolive/AdobeStock





Intensive care unit (ICU)

Intensive care areas have especially complex structures both functionally and due to the extensively deployed medical technology. These are areas in which patients are treated to restore vital functions, under either anaesthesiological or professional responsibility. Intensive care patients require a large proportion of medical resources. These often result in special requirements of hospital hygiene and infection prevention for seriously ill or infectious patients or patients at risk of infection. For this reason, special hygiene measures must be observed in this area.

In addition, the ward should exhibit a high degree of functionality, user-friendliness, safety and communication. Medical and nursing staff make a major contribution to avoiding infectious diseases. Demanding qualitative and quantitative requirements are made on their work which often becomes even more complex through frequently occurring emergency situations. For this reason, and also for infection prevention, adequate staffing of the intensive care unit is decisive. An improvement in the current staff ratio is to be sought. Intensive care units should be regarded and run as autonomous units with appropriate higher levels of staffing and equipment and specific hygienic measures. In addition, the following further planning recommendations are to be observed:

Top image:

Source: sudok1/AdobeStock

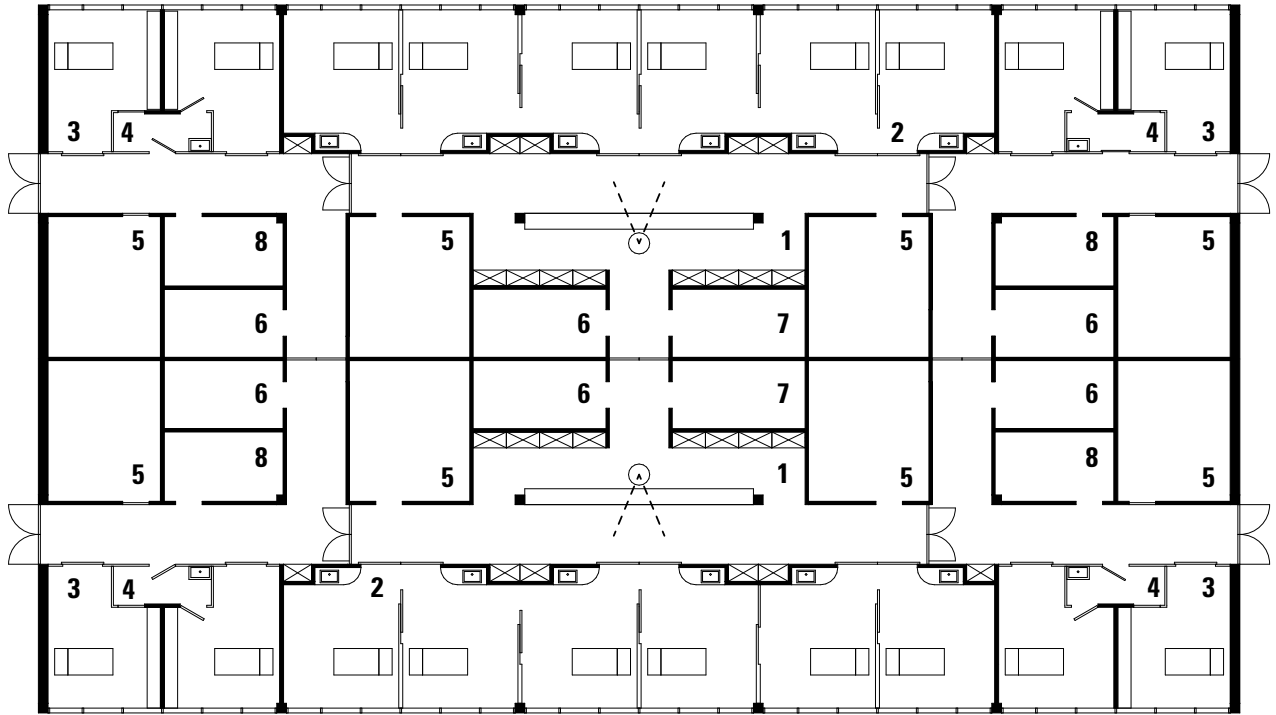

Fig 19:

Diagrammatic floor plan of an intensive care unit (ICU)

- | | |
|-----------------------------|---------------------------------------|
| 1 Support point | 5 Medicines/equipment/materials store |
| 2 Single-bed room | 6 Laboratory |
| 3 Isolation room | 7 Doctors'/conference room |
| 4 Airlock to isolation room | 8 Impure workroom |

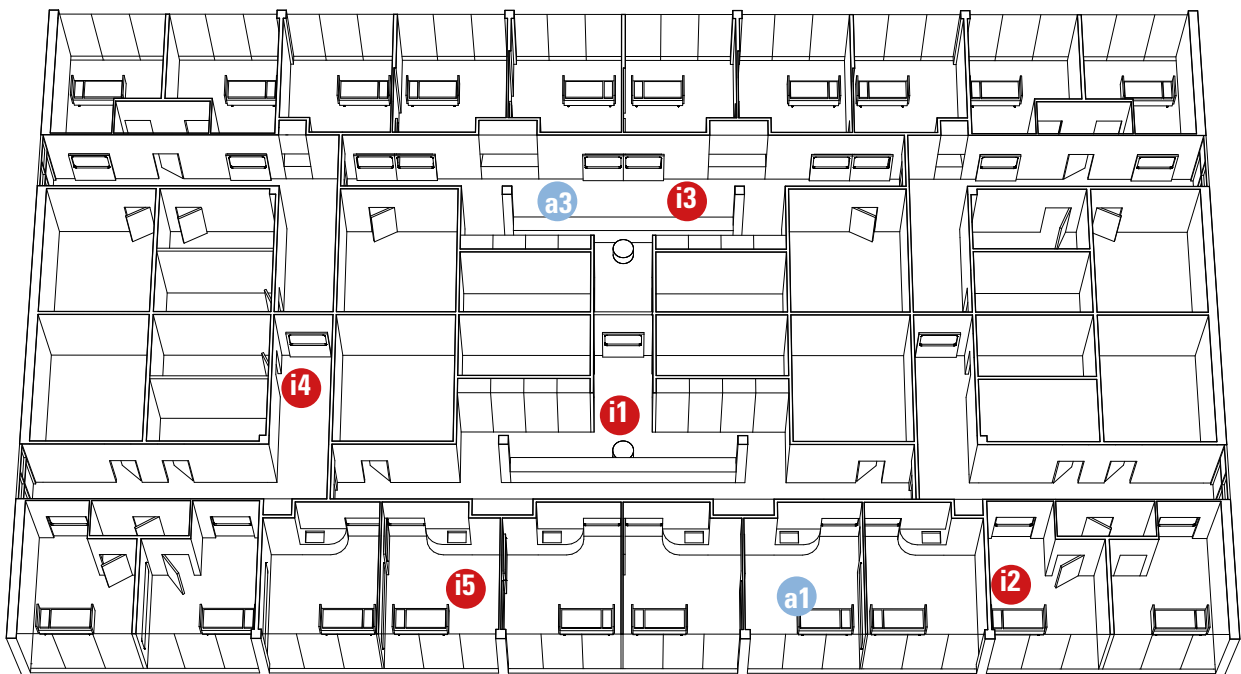

Fig. 20:

Planning recommendation for intensive care unit (ICU)

- | | |
|------------------------------|---|
| i1 Single room accommodation | a1 Spatial flexibility |
| i2 Ward size | a3 Adequately dimensioned traffic areas |
| i3 Clarity of care processes | |
| i4 Temporary separability | |
| i5 Patient room instructions | |

Layout structure recommendations

i1

Single room accommodation

- > 100% single room accommodation

i2

Ward size

- > Ward size: 8–10 beds

i3

Clarity of care processes

- > Care support point with short routes and an open view of all patient rooms

i4

Temporary separability

- > Temporarily closable areas (e.g. for cohorting)

Ward A

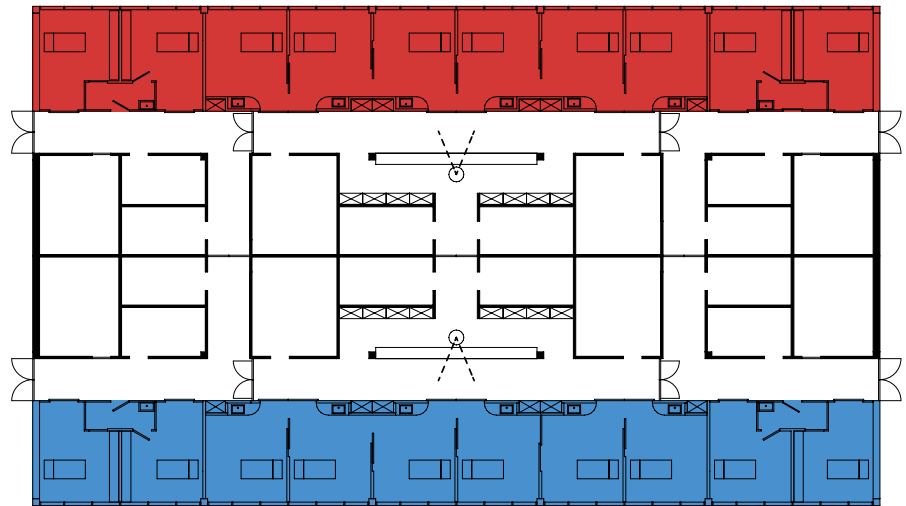

Ward B

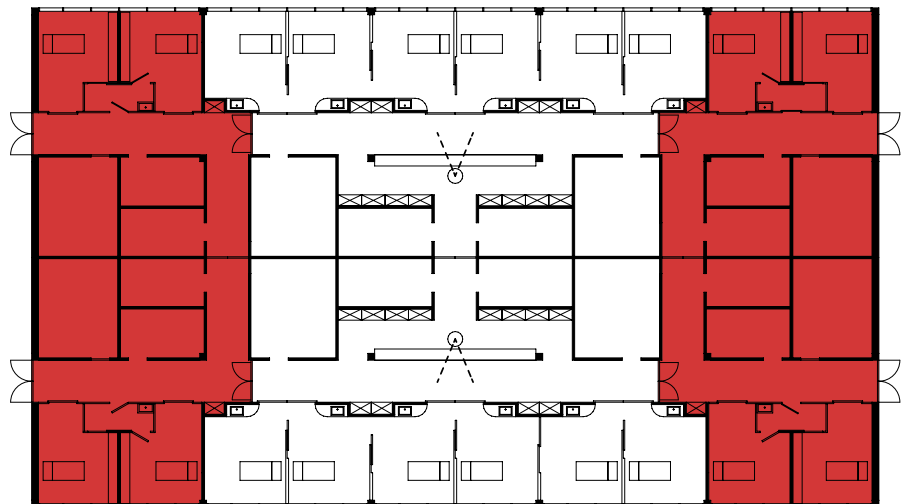
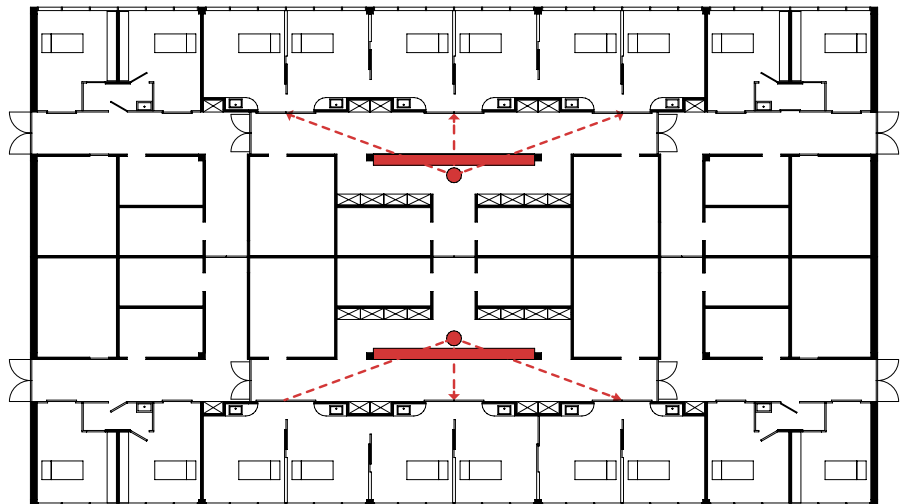

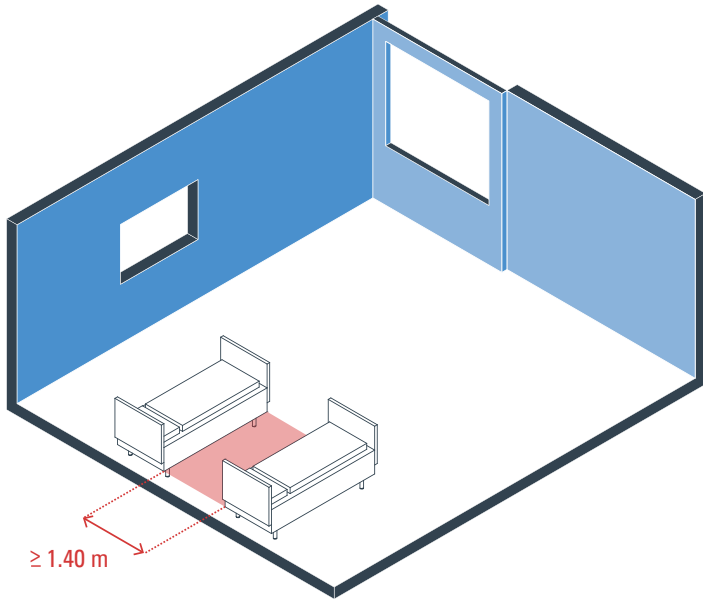

i5

Patient room instructions

- › Comply with minimum distance of 1.4 m between patient beds

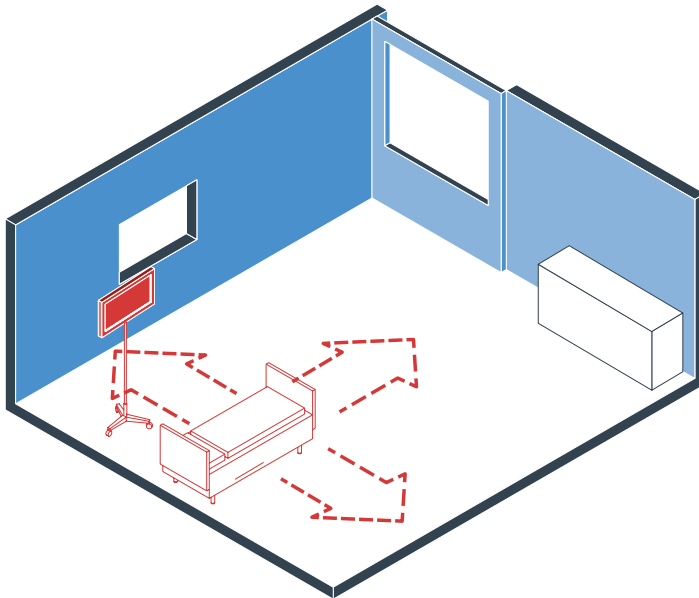

- › Plan medical technology and equipment to be moveable

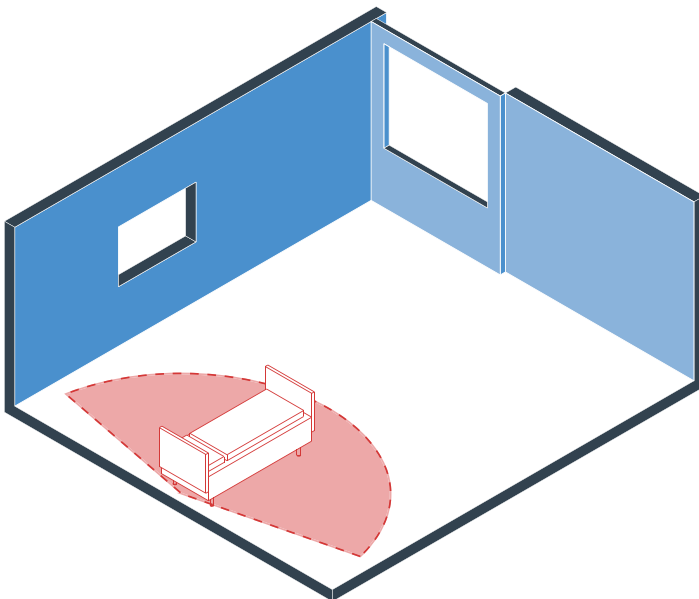

- › Allow accessibility of patient beds from all sides

i5

Patient room instructions

- › Permit spatial flexibility

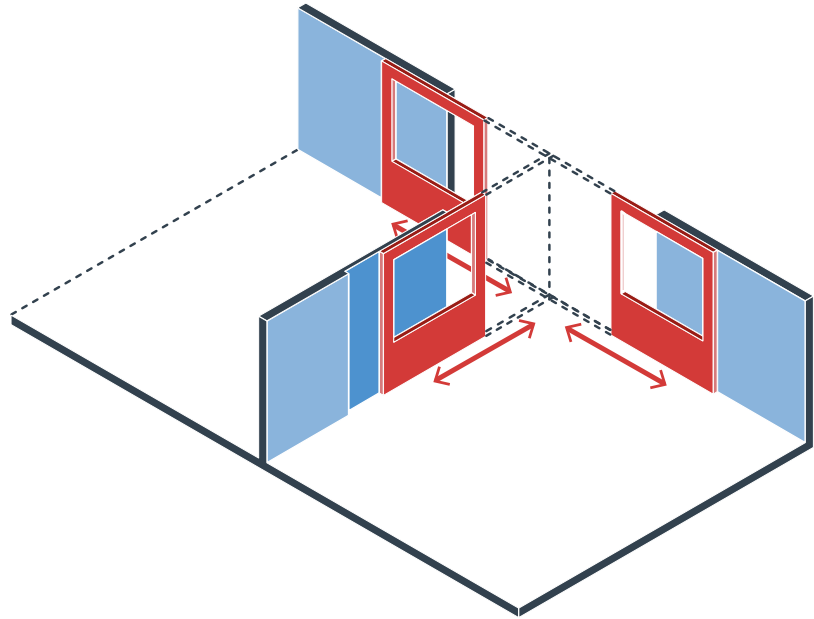

- › Plan partial glazing between patient rooms and the care corridor for hygiene-relevant care processes

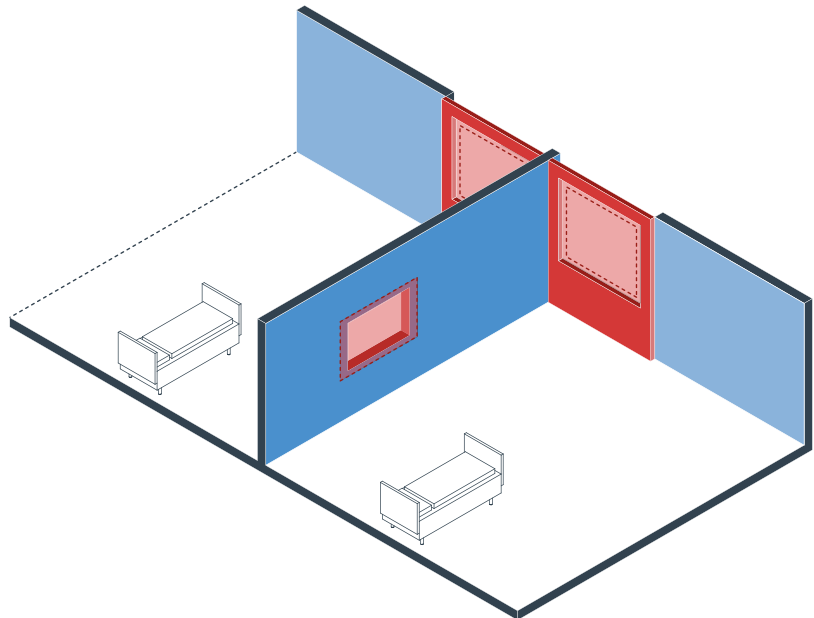

- › Locate disinfectant dispensers visibly and at arm's length next to patient beds

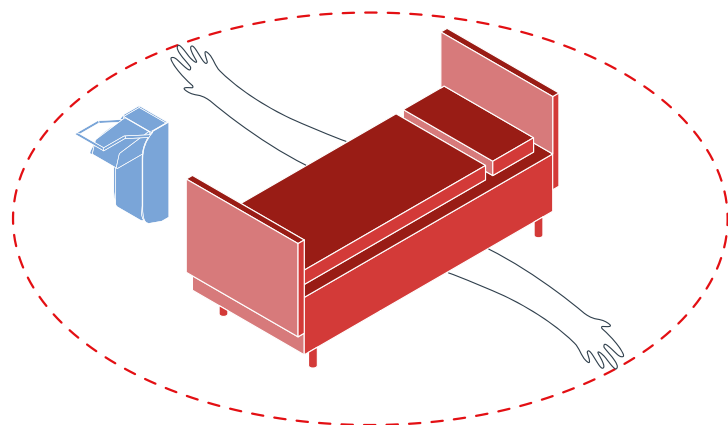























Table 4: Materials

Mechanical requirements	Floor	Wall	Ceiling
Impact-resistant			
Scratch-proof			
Abrasion-resistant			
Sealed joints			
Non-slip			
Wear-resistant			
Chemical/physical requirements			
Acid/alkali-resistant			
Solvent-resistant			
Oil/grease-resistant			
Corrosion-resistant			
Non-reflecting			
Water vapour-resistant			
Liquid-tight			
Electrically conductive			
Hygiene requirements			
Disinfectant-proof			
Easy to clean			

Material recommendation	Floor	Wall	Ceiling
Intensive care unit (ICU)	<ul style="list-style-type: none"> › (Matt) acrylic paints, coatings with interspersed conductive particles on a suitable subsurface › Polyolefins › Rubber › Ceramic tiles/stoneware with coated joints › Linoleum › Terrazzo › PVC 	<ul style="list-style-type: none"> › Emulsion paint › Varnish › Oils on subsurfaces with ramming protection fitted › Woodchip › Glass fibre fabric mesh tape with latex coating › Metals (e.g. stainless steel, anodised aluminium, copper alloys, enamelled steels) › Polyolefins › Rubber › Stoneware › PVC 	<ul style="list-style-type: none"> › Emulsion paint › Varnish › Woodchip › Glass fibre fabric mesh tape with latex coating › Metals (e.g. stainless steel, anodised aluminium, copper alloys, enamelled steels)



Normal care ward

The care area has always been at the centre of hospital construction and hygiene because on the one hand, the process of patient healing is specifically visible on this ward, and because on the other hand, the amount of space available for patient accommodation is large compared with the other hospital functions. In the end, planning faults are transferred to many wards with the same ward structure.

The relevant criterion for the location of the nursing area is the optimal connection to the other relevant functional areas in the hospital. Here, the most significant criterion is the short distance between the care area and the functional areas surgery, medical service and the specialist departments. It also makes sense to be close to intensive care and intermediate care (IMC), as many processes overlap with those of normal nursing care in terms of people and logistics. Furthermore, the proximity to facilities at the entrances, access to the outdoor areas and to other care facilities are also important for patients and visitors.

The patient room represents a special design task within the care area that has already engaged generations of architects, hospital planners and interior designers. The challenge of accommodating a range of requirements and user interests in a space of this size is immense.

Top image:

Source: Institute of Constructive Design,
Industrial and Health Care Building (IKE)
Technische Universität Braunschweig,
Tom Bauer

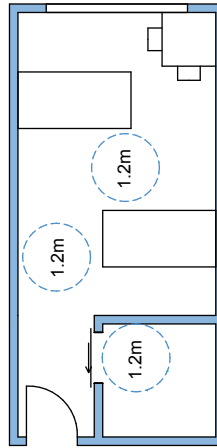
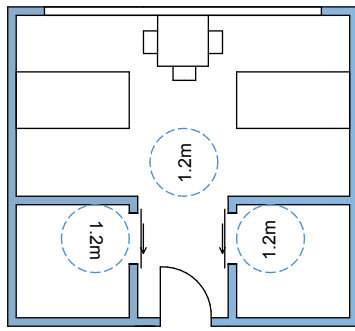

P1

Low-barrier/barrier-free patient rooms and bathrooms

Low-barrier/barrier-free dimensioning supports patients with impaired mobility in their independent movement. This can help to minimise the need for assistance and as a result also the direct and uncontrolled contact between personnel and patients.

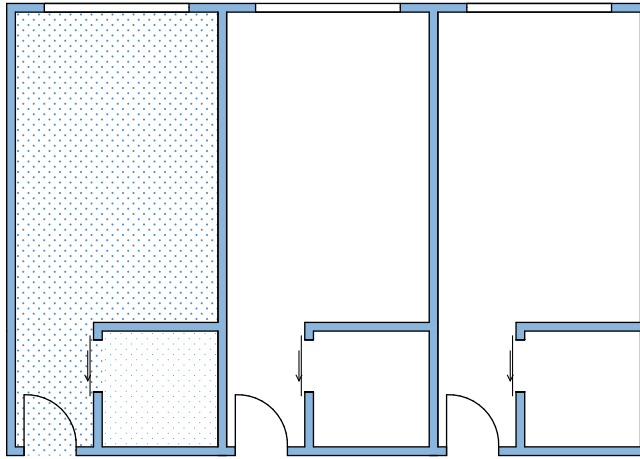

P2

Patient room same-handed

The identical layout of patient rooms prevents both staff and patients from having to adapt to different spatial situations when they are transferred to other rooms or wards. Process errors, also in terms of hygiene, can therefore be reduced.

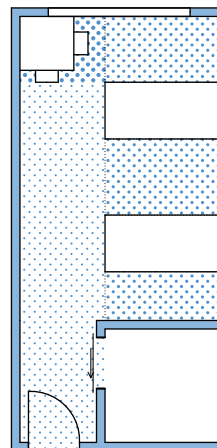
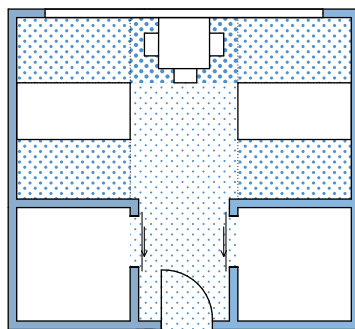

P3

Three-zone room

If each user is given a clearly defined, viewable zone, uncontrolled physical contact between users in situations of movement (where space is confined) can be avoided.

P4

Entrance area to patient rooms

An entrance area creates more spatial distance from the corridor, which is of particular advantage for isolated patients. Here, the possibility arises to keep additional protective equipment in front of the room and to place additional disinfectant dispensers without risk of injury.

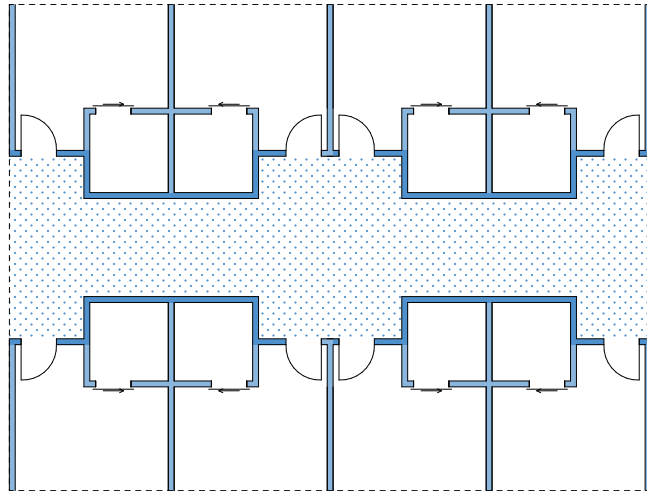

P5

Airlock can be retrofitted

The possibility of retrofitting an airlock or of providing a temporary one in nosocomial outbreak situations can serve as a constructional measure to reduce the transmission of infections.

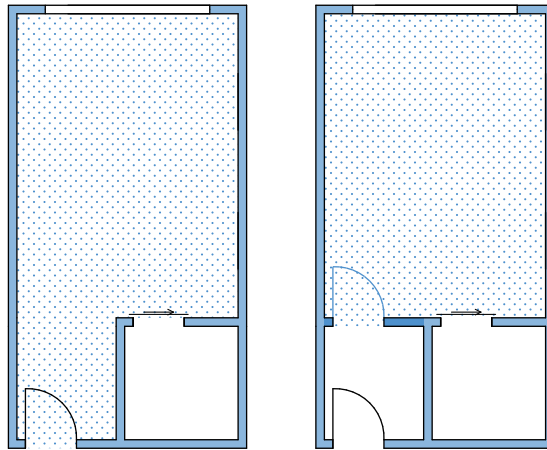

P6

Working area for staff in the patient room

If the nursing care accessories and a suitable working area are located within the room, the personnel can care for the patient in a more targeted manner, and work processes can be better planned and optimised.

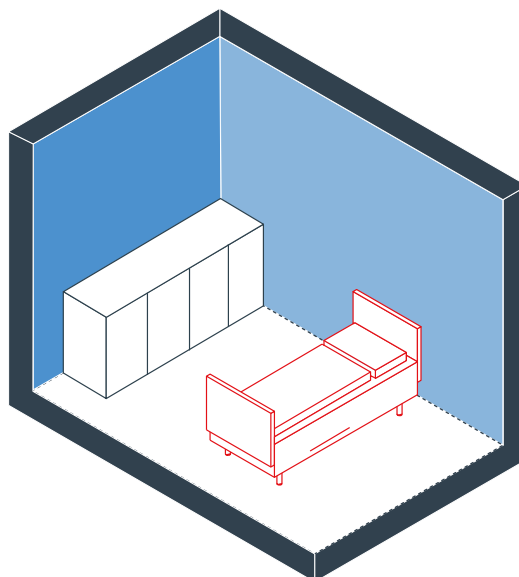

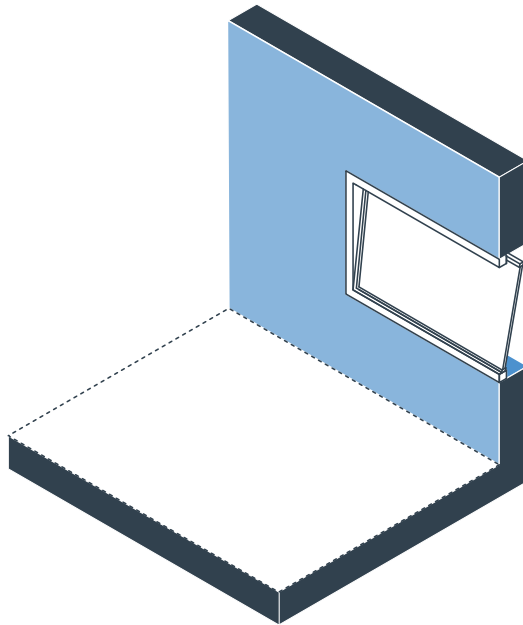

P7

Bathroom with window

The natural ventilation of a bathroom on the façade side can contribute to a better room climate, thus preventing germs from spreading.

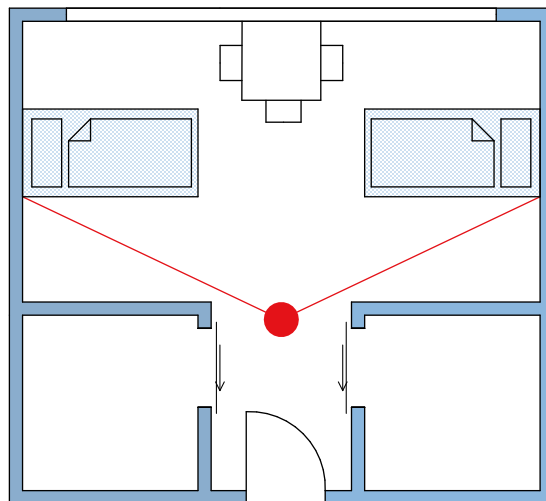

P8

Beds not positioned next to each other

(A) Avoidance of the transmission of infections by separating patients as best possible in a two-bed room. Support of personnel compliance by evading the risk of caring for two patients accommodated next to one another without disinfecting their hands.

(B) If the patient is easily visible to the personnel, better care and rapid response in the case of an emergency are ensured. Any misconduct on the part of the patient or visitors can thus be better detected and avoided.

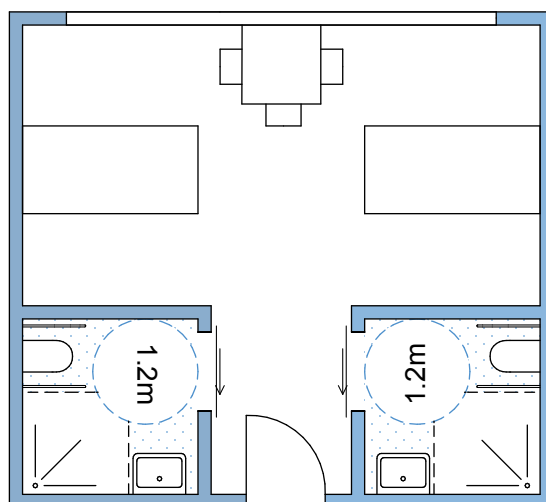

P9

Two identical bathrooms for separate use

If a separate bathroom is provided for each patient, shared contact surfaces, which can generally lead to a risk of infection, are avoided. Furthermore, contamination in one sanitary area is not necessarily transferred to the other cell.

The installation of a second washbasin reduces the risk of infection transmission via the washbasin surface or tap.

The installation of a second toilet reduces the risk of infection transmission via the toilet surface or flushing button.



General equipment

The requirements of equipment in hospitals are demanding: There are strict guidelines on hygiene standards, the distinct separation of pure and impure areas, longevity and in addition, which cleaning procedures equipment has to withstand. Equipment which can have a preventive effect on the transmission of infections requires easy-to-clean and disinfectant-proof surfaces and details, in addition to resistance against mechanical, chemical and physical effects.

It is a good idea to select equipment which has as smooth a surface as possible, joint-free surfaces and low surface energy. The surface areas of technical equipment such as e.g. medical technology and Electronic data processing (EDP) should be reduced to a minimum. The hygienic surface disinfection to be performed from the floor to all work surfaces and device surfaces can then be performed faster and more effectively.

At the same time, cupboards, counters, work surfaces and storage solutions should correspond to the individual requirements of users. Technical equipment, connections and processes also have to be integrated in many places.

When equipping rooms, the planner should be aware that in addition to requirements for functionally and hygienically sensible surfaces a cosy ambience also supports patients' recovery and increases staff satisfaction levels.

Top image:

Source: denisismagilov/AdobeStock

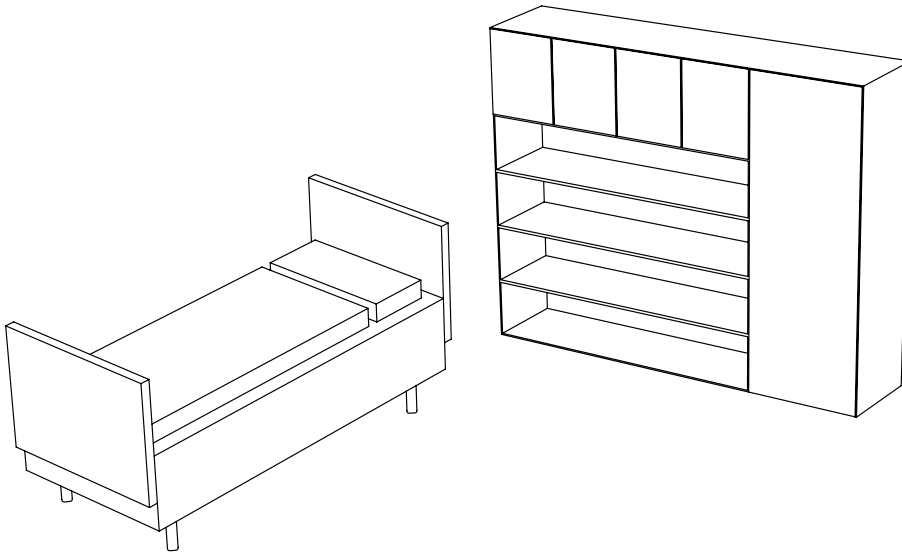

















Fig. 21

General equipment

- › Resistant surfaces especially towards disinfectants for disinfecting surfaces and hands
- › Use of easy-to-clean surfaces (smooth and low surface energy)
- › Select abrasion-resistant materials
- › Equipment with rounded edges to lower the risk of injury and improve cleaning
- › Select equipment with jointless design as far as possible
- › High wear resistance of equipment to minimise brought-in contamination in the hospital environment

Table 5: Materials

Mechanical requirements	Modular furniture	Seating furniture
Impact-resistant		
Scratch-proof		
Abrasion-resistant		
Sealed joints		
Non-slip		
Wear-resistant		
Abrasion-resistant		
Chemical/physical requirements		
Acid/alkali-resistant		
Solvent-resistant		
Oil/grease-resistant		
Corrosion-resistant		
Non-reflecting		
Water vapour-resistant		
Liquid-tight		
Electrically conductive		
Hygiene requirements		
Disinfectant-proof		
Easy to clean		

Conclusion

The occurrence and increasing spread of multiresistant germs and nosocomial infections in German hospitals poses a major problem. A great deal is undertaken by medicine and hospital management to avoid and contain this. The spatial circumstances and structures of hospital buildings have not, however, hitherto been the focus of observations on preventive medicine.

But there are definitely interactions between the arrangement, distribution and size of the hygiene-relevant rooms or areas of a hospital and the danger of the occurrence and spread as well as the combating of hospital-specific infections.

The planning and realisation of future hospital buildings could make a significant contribution to combating nosocomial infections if greater attention is paid to the design of hygiene-optimised building and room structures than there has been so far. Planning recommendations have been sketched out here.

In future, the hospital will also have to react to further changes. Here, planning must consider an range of structural, technical, material development-related and organisational aspects. The research and development of innovative spatial contexts from an infection prevention perspective will become even more important in the future.

With all the necessary planning of a highly complex and hygiene-robust hospital, however, the architect must not forget the most important function of healthcare buildings apart from the spatial design: namely to detect patients' diseases, to treat them and ideally to cure them. The challenges to architecture will therefore remain.

Appendix

Questionnaire

Questionnaire on the constructional hospital structure in Germany

For the first time, it was possible to enquire about the state of building structures in German hospitals with the aid of the Hospital Infection Surveillance System (Krankenhaus-Infektions-Surveillance-System – KISS) of the National Reference Centre for the Surveillance of Nosocomial Infections (Nationales Referenzzentrum für Surveillance von nosokomialen Infektionen – NRZ). The functions of the National Reference Centre are exercised by the Institute for Hygiene and Environmental Medicine at the Charité – Universitätsmedizin in Berlin. The questionnaire was possible due to the heterogeneous amalgamation of interdisciplinary working research facilities whose “HYBAU+” project forms the basis of this publication. KISS has been recording nosocomial infection rates and multiresistant pathogens (MRP) since 1997 [34].

The questionnaire was sent as an online questionnaire to the staff responsible for KISS (hospital hygienists and hygiene specialists). Questioning of all hospitals participating in KISS took place from March to June 2015. The invitation to participate was sent to 1,357 of Germany’s roughly 2,000 hospitals. Respondents could complete one questionnaire for the entire hospital and one short questionnaire each for intensive care units and neonatal wards. 621 hospitals participated in the survey. This represents a return rate of 46%. The questionnaire on intensive care units was answered by 534 wards from 368 hospitals. Of 246 hospitals questioned, 127 of the neonatal wards specified data on their building structures.

The survey covered the current state of the building structure of hospitals in Germany. The questionnaire ranged from the location of the hospital, whether urban or rural, through the cubic volume of the building and the geometric structure of the functional areas to details such as e.g. the equipping of rooms with hand disinfectant dispensers.

The questionnaire collected a broad range of data such as the hospital’s year of construction, dates of building renovations/changes and also structural details of the hospital building and selected departments. Further important aspects included inter alia the number of single, double and multi-bed rooms, the room size and the distance of the care support point to the furthest patient room. In order to determine the structural details, the Institute of Industrial Building and Constructive Design of the Technische Universität Braunschweig developed pictograms which were integrated into the questionnaire.

Location – where is your hospital located?

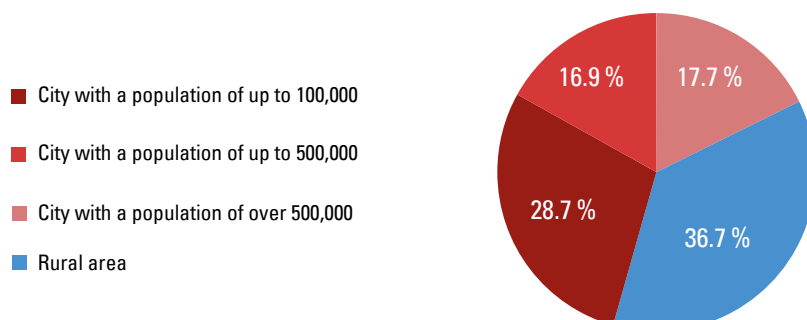

Location – when was the hospital built?

Year of construction

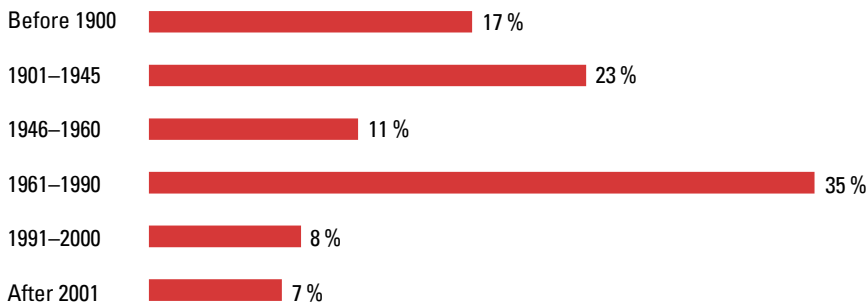

Location – when were the last building measures carried out?

Building measures

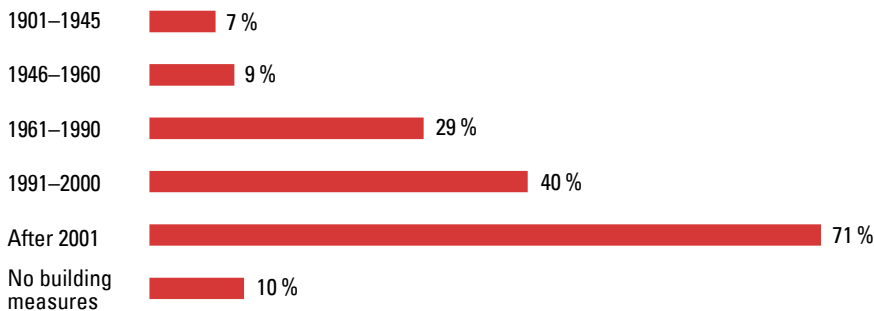

An initial estimation of the actual constructional situation of hospitals compared with corresponding recommendations on structural infection prevention was set out based on the results of the questionnaire. The result showed the gap between the target and actual conditions in order to reveal the corresponding need to act in certain areas. This was included in the first part of this publication in the form of recommendations.

On the other hand, the findings on building structure were placed in relation to the findings from the collection of data on infection rates of the corresponding functional areas in order to detect a possible connection between the building structure and the occurrence of certain infections. Parts of this analysis can be examined in the following publication: “Ausstattung mit Händedesinfektionsmittelspendern und Einbettzimmern in Hinblick auf die Infektionsprävention – eine Bestandsaufnahme in Krankenhäusern in Deutschland” (Analysis of contemporary hospital infrastructure pertaining to infection prevention in Germany) [6]. These findings were directly integrated into the planning recommendations in this publication.

The data gathered from the questionnaire was edited with the aid of descriptive statistics methods. The result is set out on the following pages.

Location – when were the last building measures carried out?

Intensive care unit

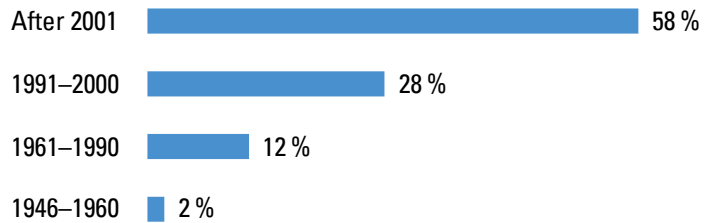

Haematology/Oncology

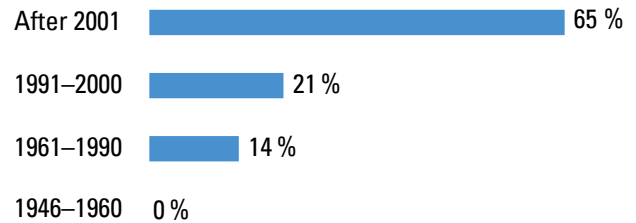

Neonatal ward

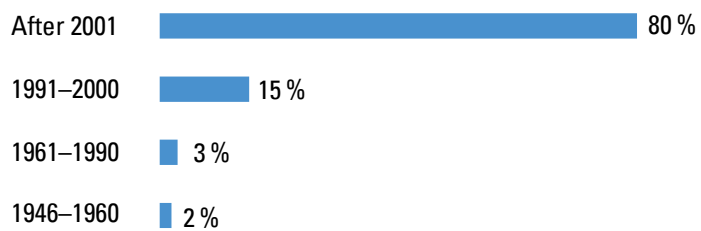

Operating area

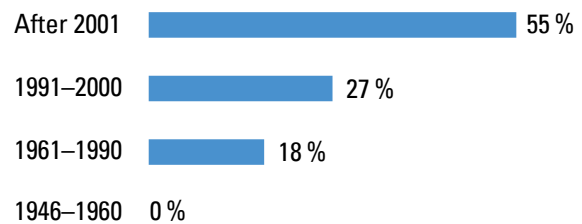

Normal care ward

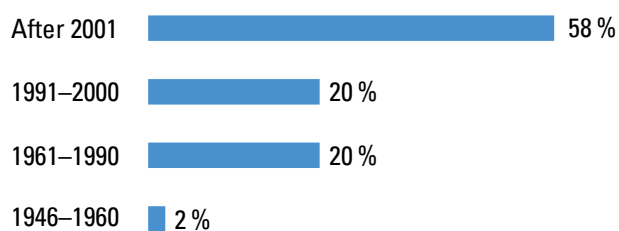

Emergency Department

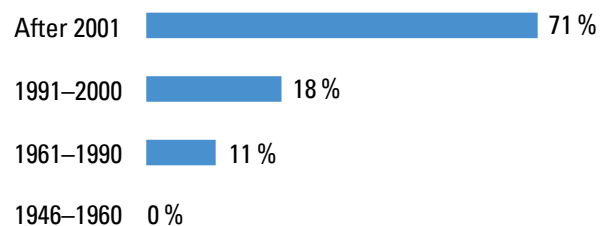

Hospital typologies – what is your hospital’s building structure?

Evolved structure

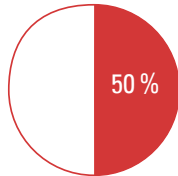
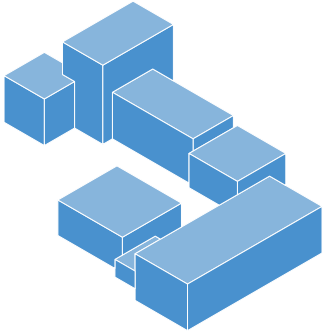

Evolved structure, parts of buildings have been joined together over time, no uniform style

Solitary

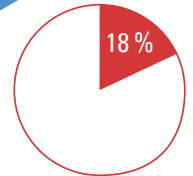
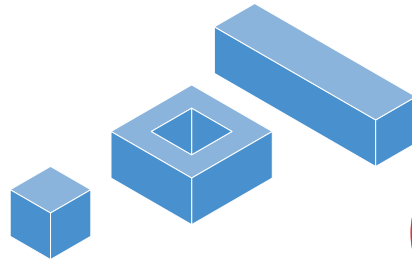

Stand-alone, compact building structure

Comb

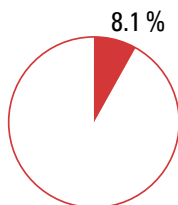
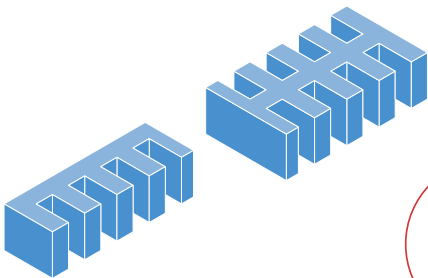

Comb structure, parts of buildings can be made accessible via a main part

Pedestal

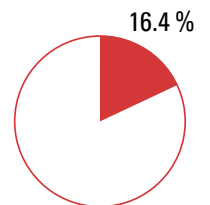
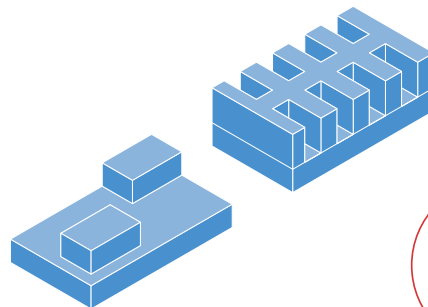

Pedestal with building

Carpet

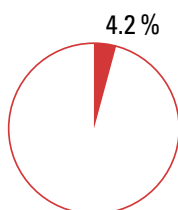
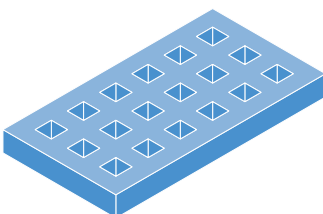

Carpet structure, several inner courtyards, extendible

Cluster

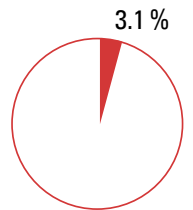
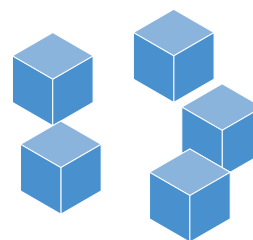

Cluster structure, individual pavilions, free-standing parts of buildings are not connected to one another but in the same architectural style and therefore from one source

What care categories does the hospital have?

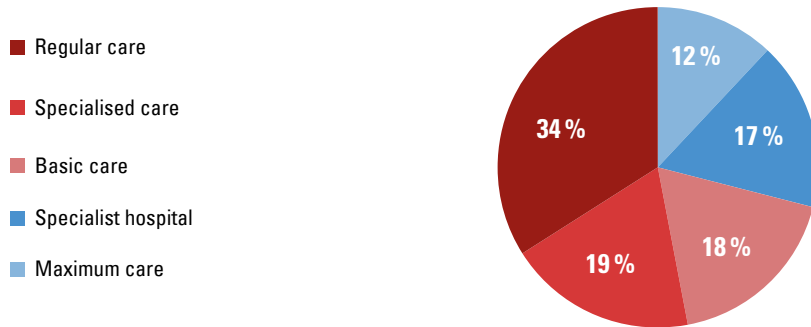

Is there a central admission department?

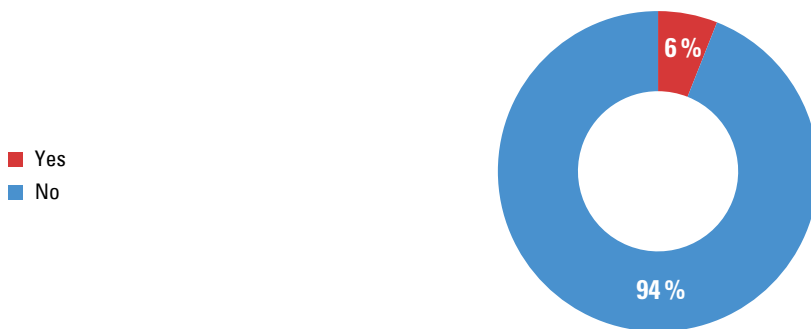

Is there a special ward for patients with multiresistant pathogens?

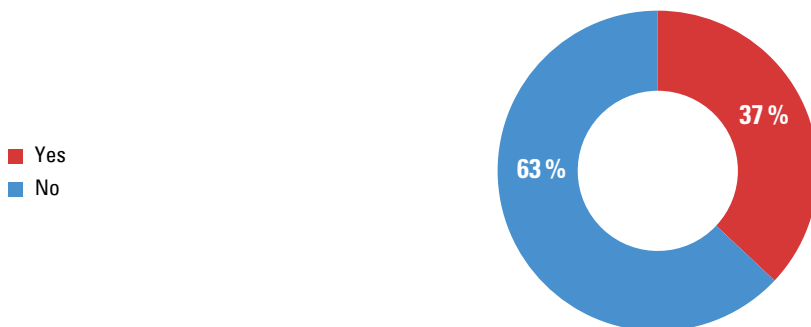

Hospital typology – are there patient rooms which do not have their own toilet?

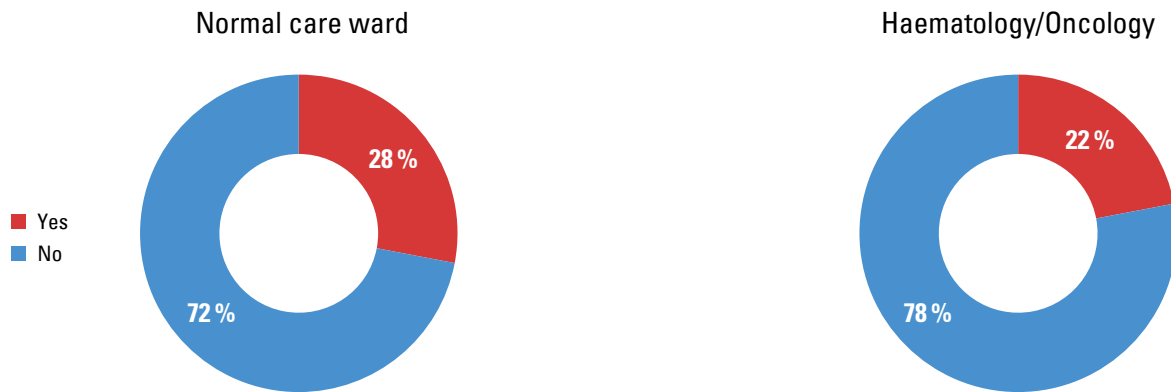

What services are outsourced and/or are outside the grounds?

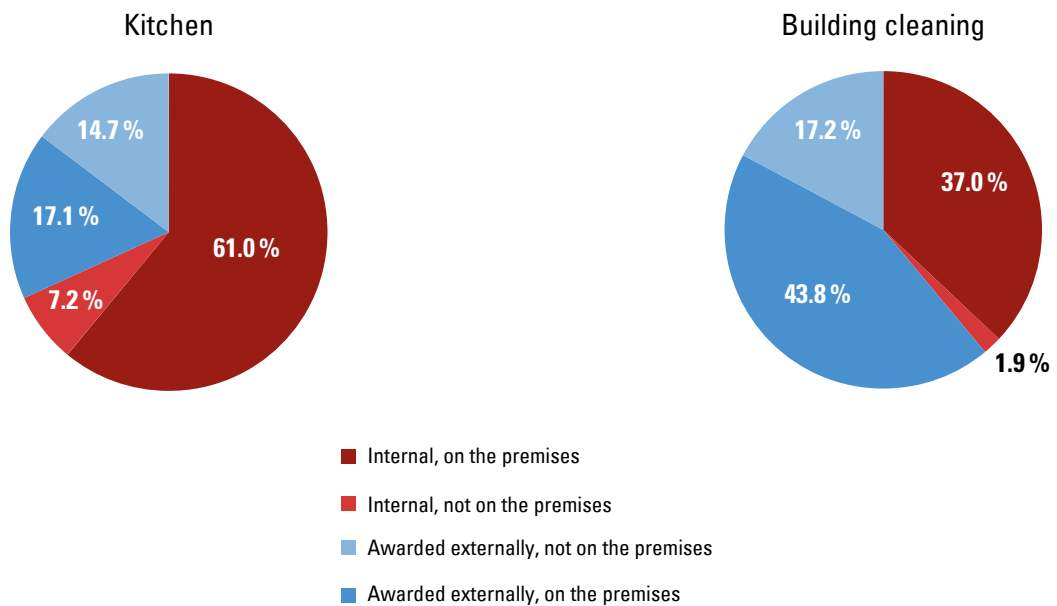

Microbiological laboratory goods supply department

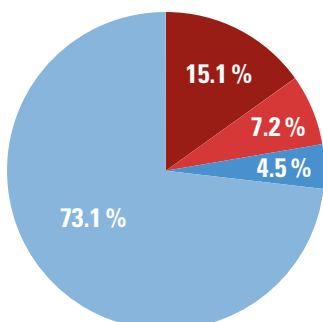

Central sterile equipment department

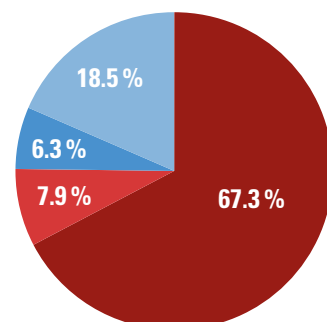

Does your hospital have an emergency department?

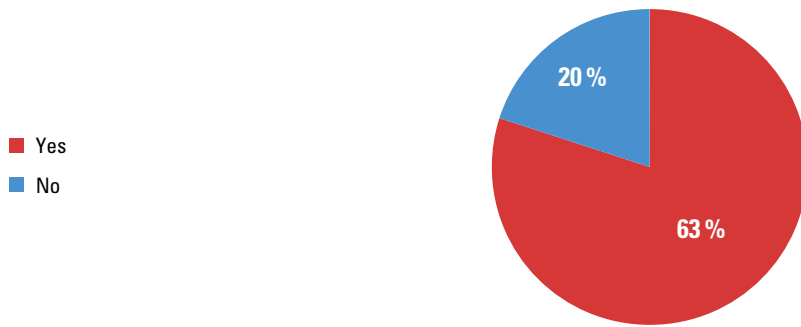

Emergency department building structure

Central corridor

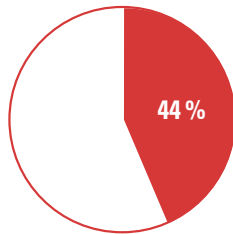

Disordered

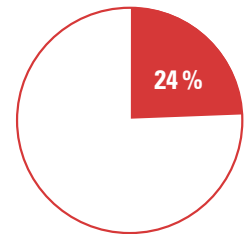
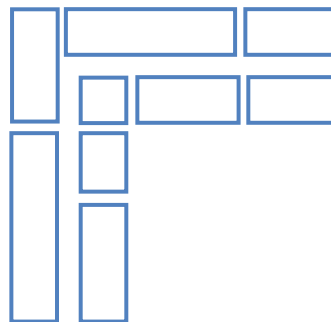

Two corridors

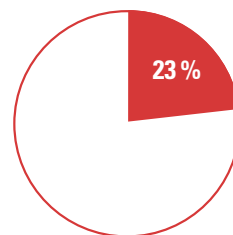
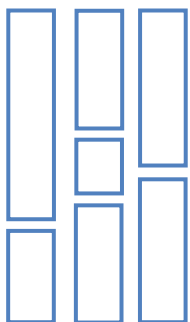

Central

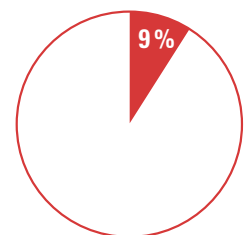
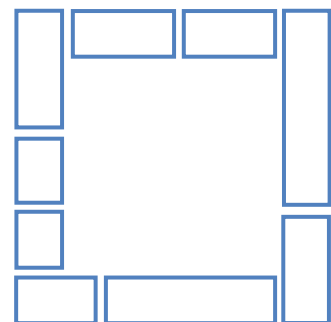

Is there a separate waiting area in the emergency department for patients with suspected infectious diseases?

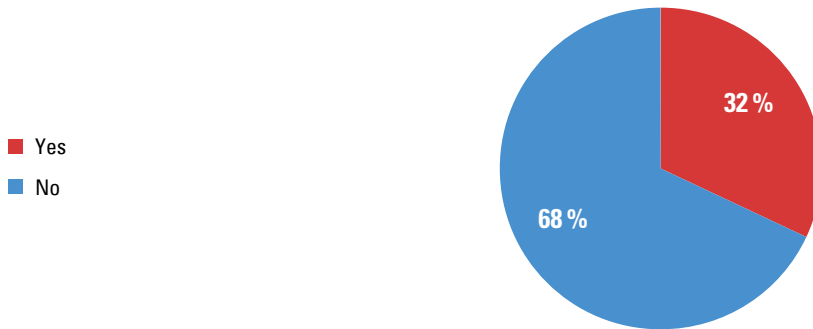

Do emergency department rooms contain more than one treatment bay and are they separated by a curtain, folding screen or the like?

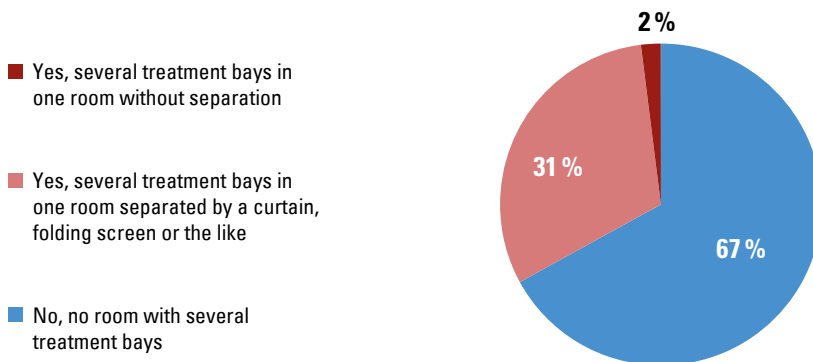

Is there a hand disinfectant dispenser within an arm's length of the examination table for every treatment bay in the emergency department?

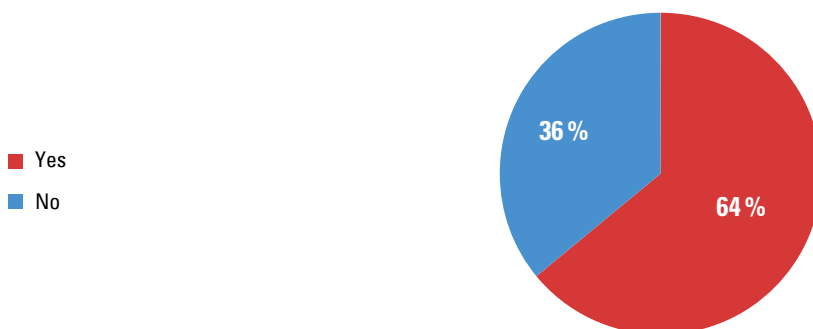

Operating area structure

- 1 Operating theatre
- 2 Induction
- 3 Discharge
- 4 Sterile equipment
- 5 Washing

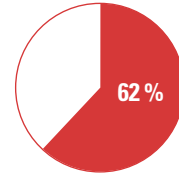
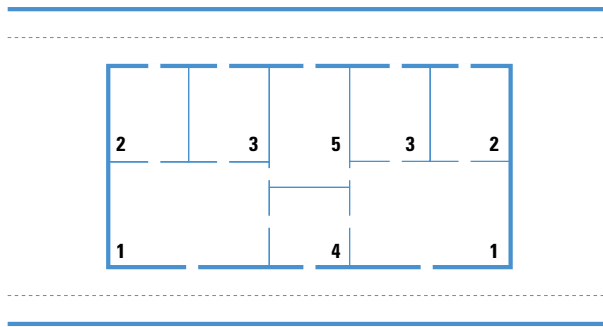

- 1 Operating theatre
- 2 Induction
- 3 Discharge
- 4 Sterile equipment
- 5 Washing

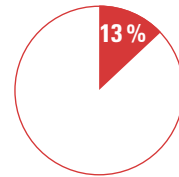
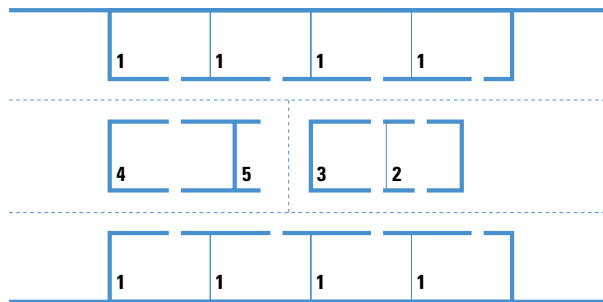

- 1 Operating theatre
- 2 Induction
- 3 Discharge
- 4 Sterile equipment
- 5 Washing

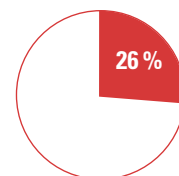
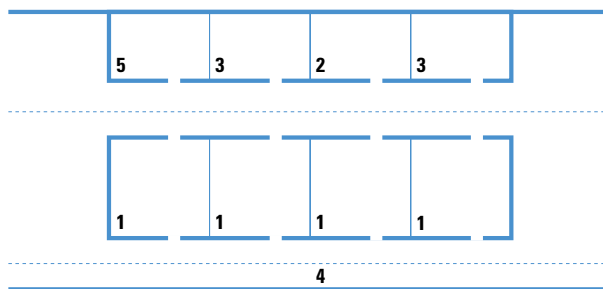

Most frequent occurrence in %

Where does induction take place in the operating area?

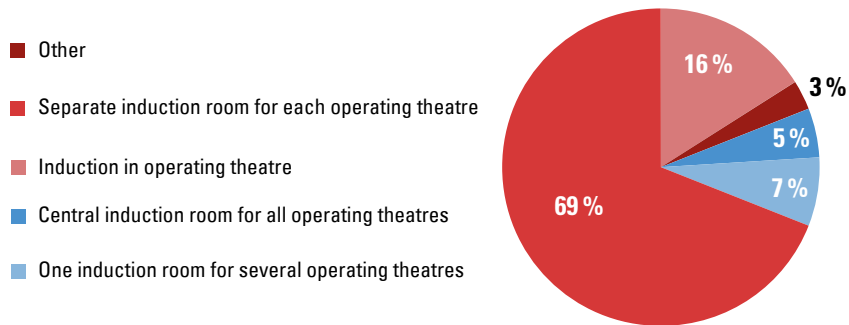

Is there a separation of septic and aseptically operating theatres?

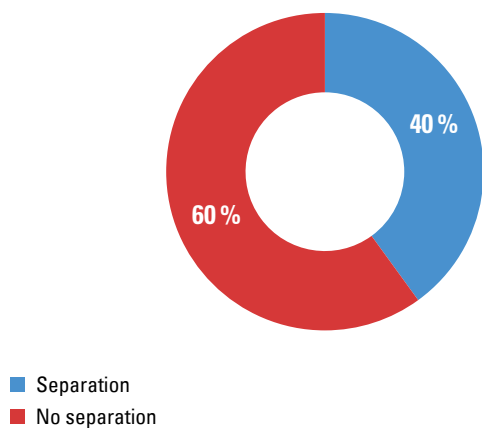

And of those, do they have separate sluices?

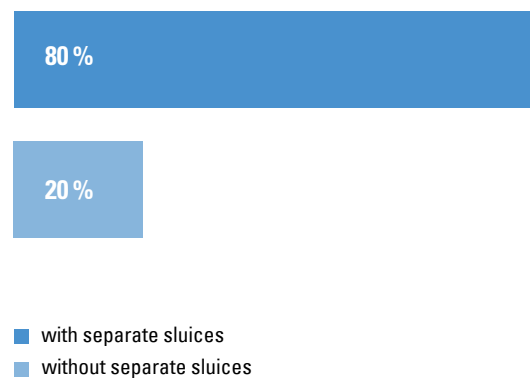

Is there a sterile corridor in instrument preparation in the operating area?

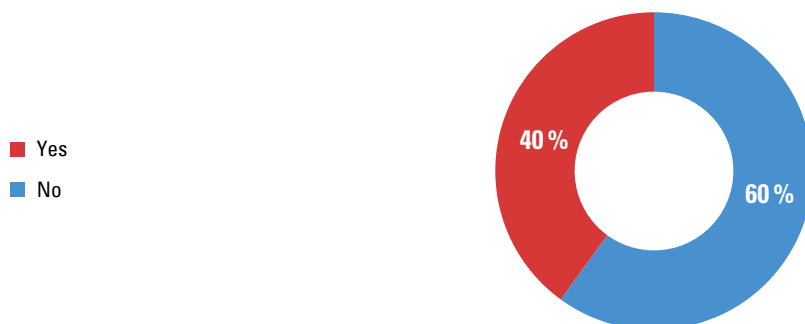

Where is technical equipment installed in the operating theatre?

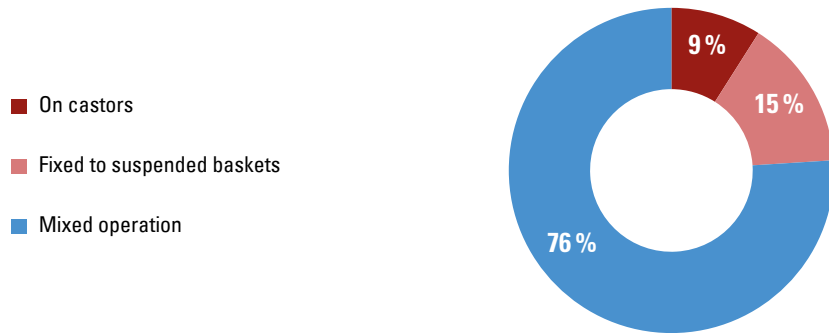

Is there a central washing area for all or several operating theatres?

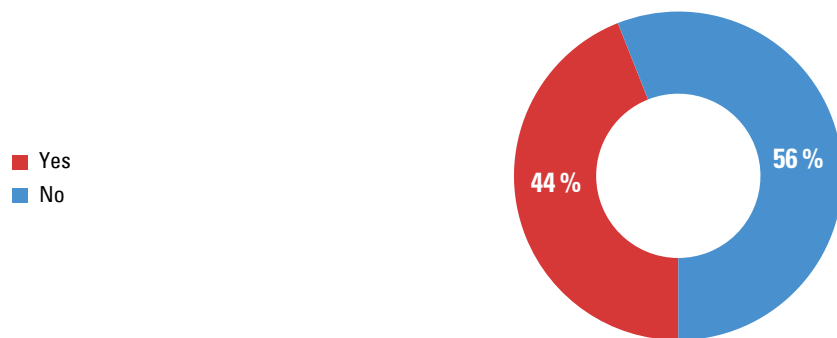

What materials are present in the operating theatre?

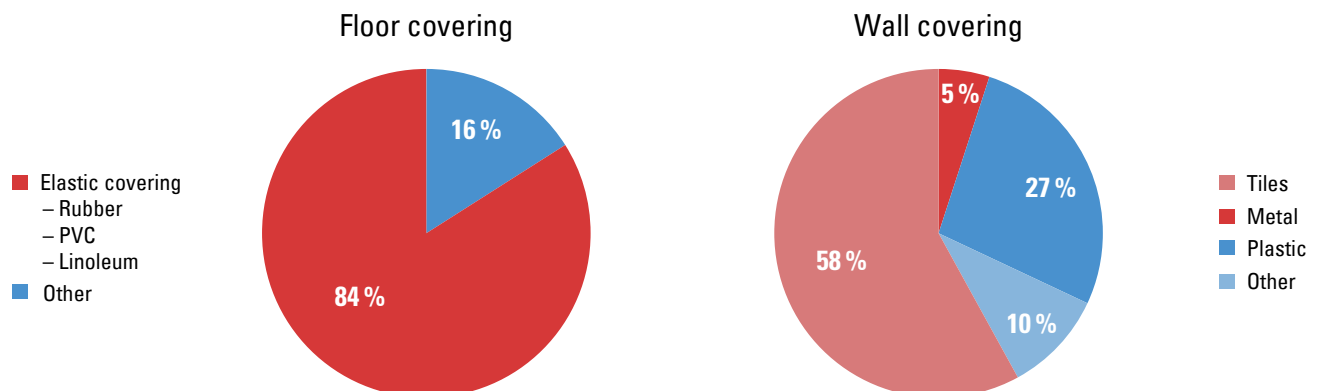

A comparison of care wards

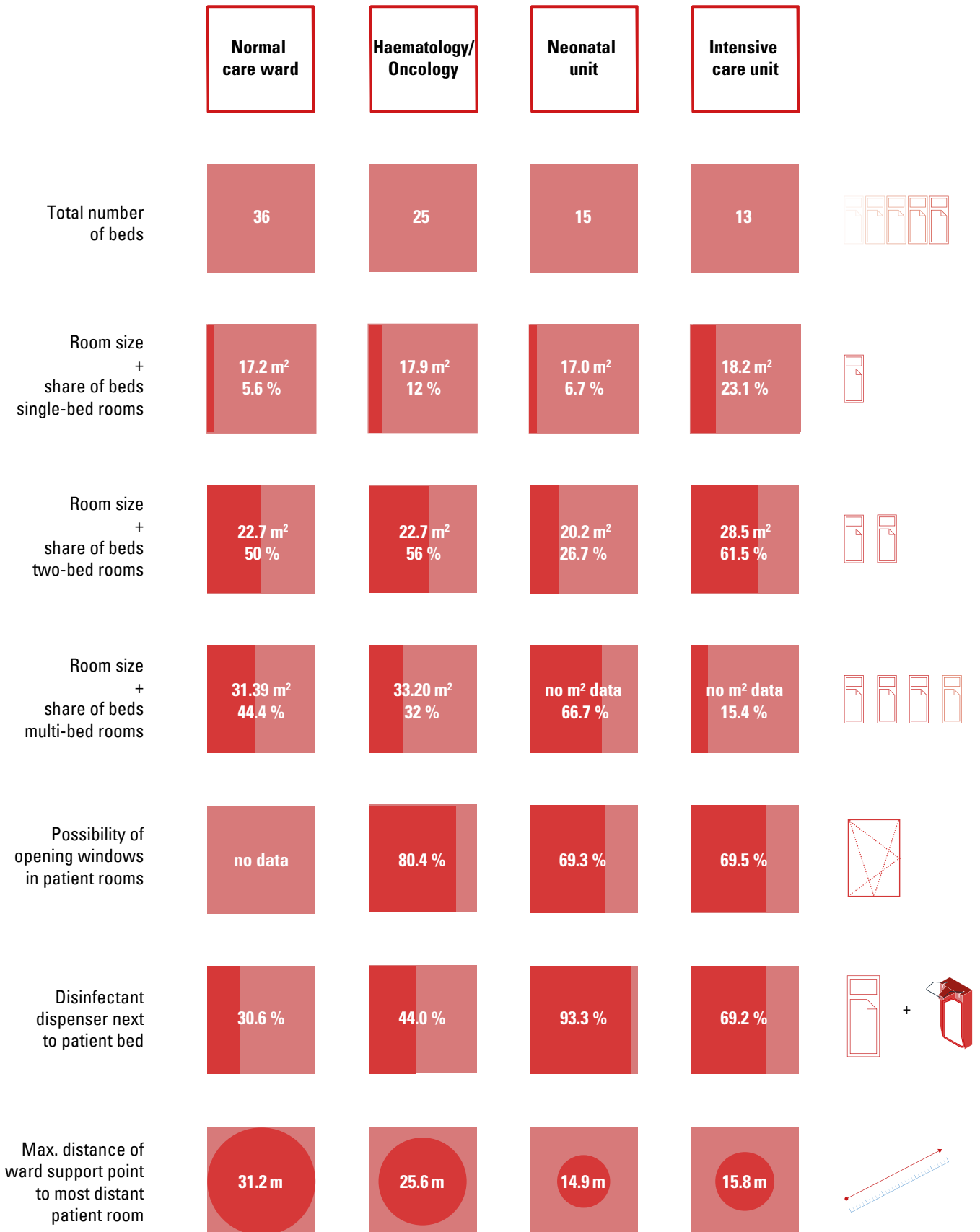

Normal care ward structure

30.9 %

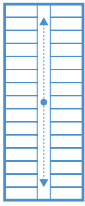

Side corridor with connection in the middle, e.g. high rise buildings

19.5 %

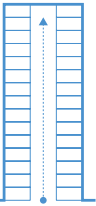

Side corridor, for example in comb structure with extensions

13.2 %

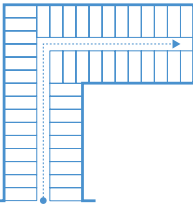

Side corridor L, for example in comb structure with extensions

10.3 %

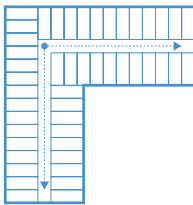

Side corridor L

10.1 %

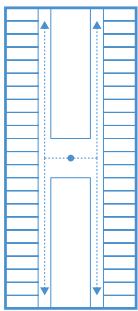

Dual corridor connected in the centre, e.g. high-rise building

Intensive care unit structure

29.6 %

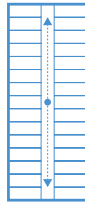

Side corridor with connection in the middle, e.g. high rise buildings

19.5 %

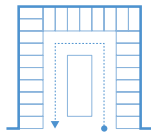

Corridor, for example in comb structure with extensions

17.0 %



Side corridor, for example in comb structure with extensions

10.3 %

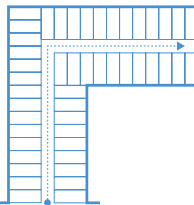

Side corridor L, for example in comb structure with extensions

8.6 %

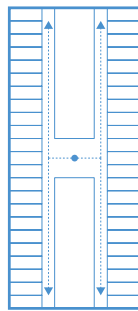

Dual corridor connected in the centre, e.g. high-rise buildings

Neonatal unit structure

31.5 %



Side corridor with connection in the middle, e.g. high rise buildings

22.8 %



Side corridor, for example in comb structure with extensions

14.2 %

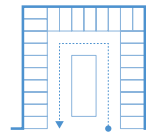

Corridor, for example in comb structure with extensions

8.6 %

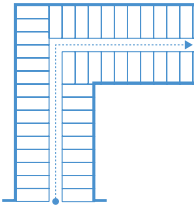

Side corridor L, for example in comb structure with extensions

10.1 %

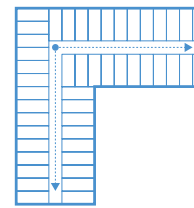

Side corridor L

Is there a haematology/oncology unit in the hospital?

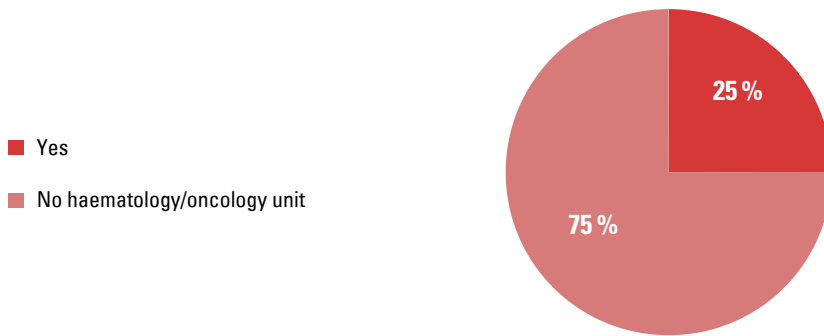

Is there an intervention room for minor interventions on the corresponding ward?

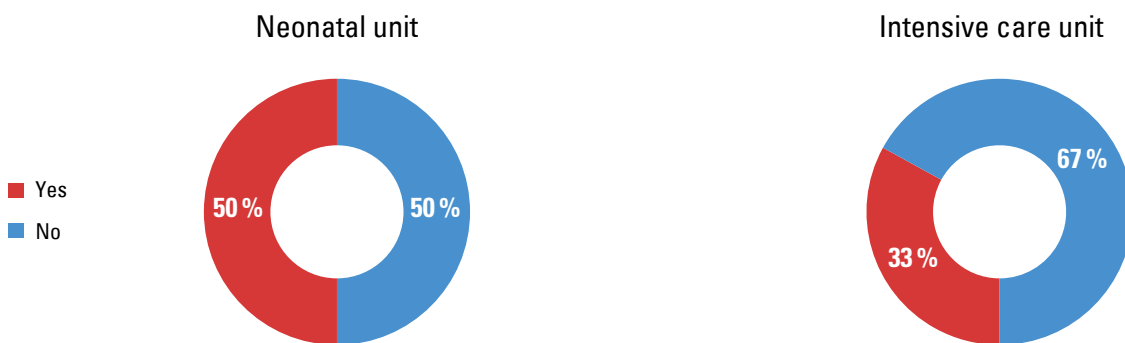

Is there a high-dose chemotherapy unit in the oncology ward?

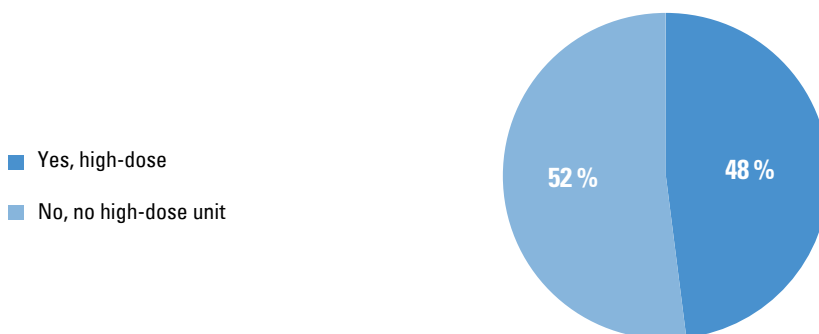

Are there windows and ventilation and air conditioning systems in the intensive care unit or in the haematology/oncology unit?

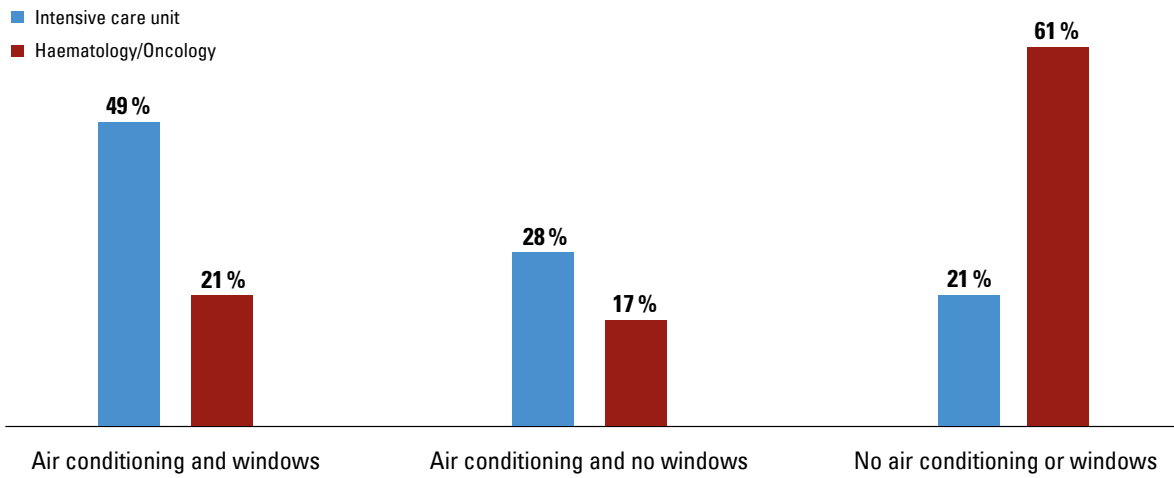

Is there a patient bath in the normal care ward?

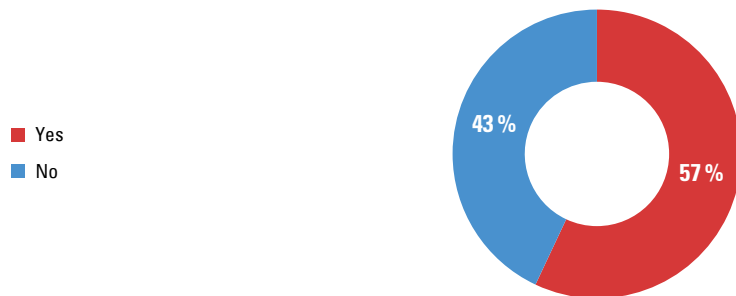

How often is the patient bath in the normal care ward used?

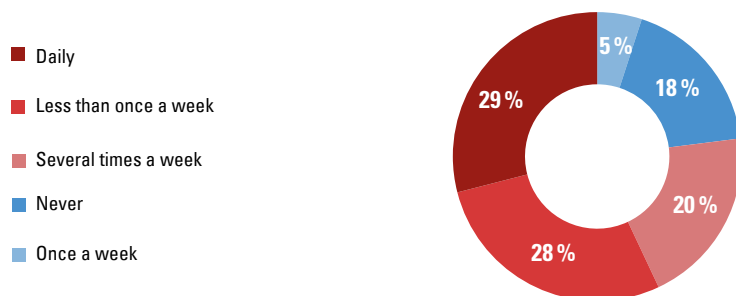

Abbreviations

A&E	Central Emergency Department
CDI	Clostridium-difficile infection, enteral infection
CSED	Central sterile equipment department
CT	Computer tomography, imaging method in radiology
DIN	German Industrial Norm
DIVI	German Interdisciplinary Association for Intensive Care and Emergency Medicine
DRG	Diagnosis Related Groups, flat-rate reimbursement system
E. coli	Escherichia coli, colibacteria which occurs in the intestine
EDP	Electronic data processing
EHEC	Enterohaemorrhagic Escherichia coli, pathogenic strains of the intestinal bacteria Escherichia coli
HOAI	Fee Structure for Architects and Engineers
ICU	Intensive care unit
IMC	Intermediate Care
KISS	Hospital Infection Surveillance System
KRINKO	Commission for Hospital Hygiene and Infection Prevention
MRGN	Multiresistant Gram-negative bacteria A figure between two and four is generally placed before the abbreviation which indicates the number of antibiotics classes – penicillins, carbapenems, gyrase inhibitors or cephalosporins – against which the respective bacterium is resistant
MRP	Multiresistant pathogens
MRSA	Methicillin-resistant Staphylococcus aureus increasingly resistant type of staphylococcus
RKI	Robert Koch Institute
SARS	Serious acute respiratory syndrome
VRE	Vancomycin-resistant enterococci
WHO	World Health Organisation

Glossary

Accessibility

Accessibility is defined in §4 of the German "Equality for Persons with Disabilities Act" (Behindertengleichstellungsgesetz - BGG) as: "Accessible (barrier free) can be applied to buildings and other structures, means of transport, technical commodities, information processing systems, acoustic and visual information sources and communication facilities, as well as other designed environments if persons with disabilities are always able to find, access and use them unaided in the usual manner and without any particular difficulty. The use of relevant disability aids is permitted."

Airlock

An airlock is a transitional space between two areas whose environment should not mix, due to different air pressure, different sterility levels, different contamination degrees or different cleanliness, etc.

Antibiotic

An antimicrobial substance that acts against pathogens and is derived from the metabolic products of microorganisms.

Aseptic

Sterile, free from contamination

Bacteria

The smallest organism of only one cell, which can give rise to decay, disease or fermentation.

Care categories

Hospitals can be ranked according to the intensity of possible patient care. There are four different care categories: Basic care, standard care, priority care and maximum care.

Chemotherapy

Drug therapy for the treatment of cancer diseases or infections

Cohorting

An infection containment approach in which patients with the same pathogens are isolated together.

Coronavirus pandemic

The coronavirus pandemic (COVID-19 pandemic) is the worldwide outbreak of the new respiratory disease COVID-19 in 2019.

Dementia

Dementia is a pattern of symptoms of different diseases, the main feature of which is the deterioration of multiple mental (cognitive) abilities compared to an earlier condition.

DIN-norm

A DIN norm or German Industrial Norm (Deutsche Industrienorm - DIN) specifies requirements for products, services and/or processes. Developed under the direction of the German Institute of Standardization, their use is voluntary.

Disinfectant dispenser

Device for dispensing disinfectants. Disinfectant dispensers must be placed in the immediate vicinity wherever hand disinfection is required.

DRG

Diagnosis Related Groups (DRG) is a patient classification system that standardise prospective payment to hospitals according to particular diagnostic categories, e.g. assigns cases (patients) to case groups based on medical condition.

Endogenous infection

An infection arising from a pathogen, mostly bacteria, already present in or on the body but previously undetected.

Exogenous infection

An infection caused by a pathogen entering a patient's body from their environment.

Haematology

Science of the constitution and diseases of the blood as well as blood-forming organs

Hand hygiene compliance

Rule-consistent application of hand hygiene

Hygiene

The extent of measures aimed at promoting and improving health through the prevention and control of diseases.

Induction room

The term for the room in which the a patient is prepared for an operation, usually through the induction of an anaesthetic. Once the anaesthetic has taken effect, the patient is then brought into the operating theatre.

Infection

A local or general impairment of the human organism by pathogens that have entered the human body.

Intermediate Care (IMC)

IMC is the bridge between the Intensive Care Unit (ICU) and its comprehensive therapy and intensive care facilities and the normal care ward, where lower staffing levels prohibit the close monitoring of patients.

Invasive procedure

A medical measure that penetrates the body, for example the taking of samples from organs, injections or operations.

KISS

The Hospital Infection Surveillance System (KISS) – is a national wide surveillance system for systematically collecting and recording hygiene-related data in medical and nursing facilities in the German healthcare system.

KRINKO

The Commission for Hospital Hygiene and Infection Prevention (KRINKO) at the Robert Koch Institute (RKI) in Berlin issues regularly updated guidelines that serve as a binding basis and standard for infection prevention measures in healthcare environments.

Meta-analysis

Consolidation of primary investigations into metadata. A quantitative and statistic means of systematically assessing previous primary research studies to derive conclusions about that body of research- It serves as an evidence-based approach to aggregating and using medical information.

Method

A method is a more or less planned approach to reaching a goal. A method can also be understood as a path to gaining knowledge.

Movement area

DIN 18025-2 sets out the movement areas in front of or beside an item of use, such as a washbasin, shower or toilet. The specified distance must be maintained.

MRSA

Many hospital infections are caused by Methicillin-resistant *Staphylococcus-aureus* strains (MRSA). *Staphylococcus aureus* is a common bacterium that colonizes the skin and mucous membranes in particular, while MRSA strains thereof are resistant to the antibiotic Methicillin.

Multiresistant pathogens

Pathogens that are resistant to the mode of action of most antibiotics.

Neonatology

The branch of applied paediatrics concerned with newborn medicine and the care of new-borns.

Nosocomial infection

Infections that arise during a stay or period of treatment in a hospital or healthcare facilities. As so-called Hospital-Acquired Infections (HAI), they should be differentiated from infections that patients may have had, or were in the incubation phase, prior to admission to the hospital.

NRZ

National Reference Centre for Surveillance of Nosocomial Infections at the Institute of Hygiene and Environmental Medicine at the Charité – Universitätsmedizin Berlin.

Oncology

The study and treatment of tumours; the branch of medicine that deals with cancer.

Prevalence

A figure in health and disease science that indicates how many people of a scientific group of a defined size have a specific disease.

Same-handed

In the "same-handed" arrangement, adjacent patient rooms, the floor plan, fittings and furnishings of adjacent rooms are identical, in contrast to the mirrored arrangement where they are reversed. Its name derives from the fact that nurses always approach the patient from the same side.

SARS

Severe Acute Respiratory Syndrome (SARS) is an infectious disease caused by the SARS coronavirus (SARS-CoV), which has the clinical picture of an atypical pneumonia. Human-to-human transmission occurs mainly through the inhalation of droplets exhaled by infected persons. Indirect transmission via contaminated surfaces and materials is also possible.

Screening

Early detection of diseases

Sepsis

Bloodstream infection, also known colloquially as blood poisoning

Sterile equipment

Instruments that have been sterilised for use.

Surveillance

The continuous, systematic collection, analysis and interpretation of health data for the planning, introduction and evaluation of medical measures.

Systematic review

Systematic review or literature survey, which employs a range of methods to collate and summarise and critically evaluate all available knowledge on a specific topic.

Triage

Standardised procedure for the systematic initial assessment of the urgency of treatment of patients in accident and emergency admissions.

VRE

Vancomycin-resistant enterococci are resistant to the antibiotic Vancomycin and can be pathogens for nosocomial infections. These enterococci are among the most common causes of urinary tract infections, wound infections and sepsis. They are pathogens of nosocomial infections.

Literature

- [1] Gastmeier, P., Geffers, C. (2008). Nosokomiale Infektionen in Deutschland. *Dtsch Med Wschr*, 133, p. 1111–1115.
- [2] W. Sunder, J. Moellmann, O. Zeise und L. Jurk, *Das Patientenzimmer: Planung und Gestaltung*, Basel: Birkhäuser Verlag, 2020, p. 15-17.
- [3] KHG Krankenhausfinanzierungsgesetz, Gesetz zur wirtschaftlichen Sicherung der Krankenhäuser und zur Regelung der Krankenhauspflegesätze, original version 1972, new publication 1991, last revised 2019).
- [4] Ernst & Young, *Krankenhauslandschaft im Umbruch*, Stuttgart: Ernst & Young, 2010, p. 9 *Gesundheitsberichterstattung des Bundes (GBE Bund)*, 2016, *Intensivmedizinische Versorgung in Krankenhäusern, Anzahl Betten*. <http://www.gbe-bund.de/oowa921>, accessed on 07/04/2016.
- [5] R. Wischer und H.-U. Riethmüller, *Zukunftsoffenes Krankenhaus – Ein Dialog zwischen Medizin und Architektur*, incl. supplementary booklet, Vienna: Springer, 2007.
- [6] *Gesundheitsberichterstattung des Bundes (GBE Bund)*, 2016, *Intensivmedizinische Versorgung in Krankenhäusern, Anzahl Betten*. <http://www.gbe-bund.de/oowa921>, accessed on 07/04/2016.
- [7] Grundmann, H.-J., Bärwolff, S., Schwab, F., Tami, A., Behnke, M., Geffers, C. et al. (2005). How many infections are caused by transmission in intensive care units? *Crit Care Med*, 33, p. 946–951.
- [8] Kola, A., Schwab, F., Bärwolff, S., Eckmanns, T., Weist, K., Dinger, E. et al. (2010). Is there an association between nosocomial infection rates and bacterial cross transmission. *Crit Care Med*, 38, p. 46–50.
- [9] Stiller, A., Salm, F., Bischoff, P., Gastmeier, P. (2016). Relationship between hospital ward design and healthcare-associated infection rates: a systematic review and meta-analysis. *Antimicrobial Resistance Infect Control*, 5, p. 51.
- [10] World Health Organization (WHO) (2009). *WHO guidelines for hand hygiene in health care*. Geneva: WHO.
- [11] Stiller, A., Schröder, C., Gropmann, A., Schwab, F., Behnke, M., Geffers, C. et al. (2016). Ausstattung mit Händedesinfektionsmittelspendern und Einbettzimmern im Hinblick auf die Infektionsprävention. Eine Bestandsaufnahme in Deutschland. *Bundesgesundheitsbl*, 59, p. 986–991.
- [12] KRINKO (2016). *Händehygiene in Einrichtungen des Gesundheitswesens*. *Bundesgesundheitsbl*, 59, p. 1189–1220.
- [13] KRINKO (2010). *Anforderungen an die Hygiene bei der medizinischen Versorgung von immunsupprimierten Patienten*. *Bundesgesundheitsbl*, 53, p. 357–388.
- [14] KRINKO (2015). *Infektionsprävention im Rahmen der Pflege und Behandlung von Patienten mit übertragbaren Krankheiten*. *Bundesgesundheitsbl*, 58, p. 1151–1170.

- [15] DIVI (2011). Empfehlungen zur Struktur und Ausstattung von Intensivstationen. <https://www.divi.de/empfehlungen/publikationen/intensivmedizin/399-empfehlungen-zur-struktur-von-intensivstationen-langversion/file>. (Last accessed on 10/01/2018).
- [16] Department of Health. In-patient care. Health Building Note 04-01: adult in-patient facilities. 2013.
- [17] Pennington, H., Isles, C. (2013). Should hospitals provide all patients with single rooms? *BMJ*, 347:f5695, doi: 10.1136/bmj.f5695.
- [18] Maben, J., Griffiths, P., Penfold, C., Simon, M., Anderson, J., Robert, G. et al. (2016). One size fits all? Mixed methods evaluation of the impact of 100 % single-room accommodation on staff and patient experience, safety and costs. *BMJ Qual Saf*, 25, p. 241–256.
- [19] Sadatsafavi, H., Niknejad, B., Zadeh, R., Sadatsafavi, M. (2016). Do cost savings from reductions in nosocomial infections justify additional costs of single-bed rooms in intensive care units? A simulation case study. *J Crit Care*, 31, p. 194–200.
- [20] Infektionsschutzgesetz. Gesetz zur Verhütung und Bekämpfung von Infektionskrankheiten beim Menschen (Infektionsschutzgesetz – IfSG). Bundesgesetzblatt 2000, p. 1.045, last revised 08/07/2011.
- [21] KRINKO (2002). Anforderungen der Hygiene an die baulich-funktionelle Gestaltung und apparative Ausstattung von Endoskopieeinheiten. *BGBI Gesundheitsforsch – Gesundheitssch*, 45, p. 412–414.
- [22] Medizinproduktegesetz (MPG) dated 07/08/2002, Bgbl 2002; I: 3, p. 146, last revised 24 July 2010.
- [23] Arzneimittelgesetz (AMG) dated 12/12/2005, BGBI I p. 3.394, last revised 22 December 2010.
- [24] Kreislaufwirtschafts- und Abfallgesetz (KrW/AbfG), Gesetz zur Förderung der Kreislaufwirtschaft und Sicherung der umweltverträglichen Beseitigung v. 27.9.1994, Bgbl I p. 2.705, last revised 11/08/2009.
- [25] Muster einer Verordnung über den Bau und Betrieb von Krankenhäusern (Krankenhausbauverordnung – KhBauV0), version December 1976.
- [26] DIN 13080 (2016). Gliederung des Krankenhauses in Funktionsbereiche und Funktionsstellen. Berlin.
- [27] DIN 1946-4 (2008). Raumluftechnische Anlagen in Gebäuden und Räumen des Gesundheitswesens.
- [28] VDI-Richtlinie 6022 (2011). Raumluftechnik, Raumlufqualität – Hygieneanforderungen an raumluftechnische Anlagen und Geräte.

- [29] VDI-Richtlinie 6023 (2013). Hygiene in Trinkwasser-Installationen – Anforderungen an Planung, Ausführung, Betrieb und Instandhaltung.
- [30] Deutsche Interdisziplinäre Vereinigung für Intensiv- und Notfallmedizin (DIVI) (2010). Empfehlungen zur Struktur und Ausstattung von Intensivstationen.
- [31] Landesamt für Gesundheit und Soziales M-V (LAGuS): Bauanforderungen und funktionelle Empfehlungen aus der Sicht der Hygiene, 11/2016.
- [32] Bayr. Landesamt für Gesundheit und Lebensmittelsicherheit (LGL): Erläuterungen zur Checkliste Versorgung von immunsupprimierten Patienten, modularer Leitfadens ab 2014.
- [33] Bauministerkonferenz – Konferenz der für Städtebau, Bau- und Wohnungswesen zuständigen Minister und Senatoren der Länder (ARGEBAU), Fachkommission Bau- und Kostenplanung, Netzwerk Krankenhausbau: Planungshilfe Intensivpflege, 2018.
- [34] Gastmeier, P., Sohr, D., Schwab, F., Behnke, M., Zuschneid, I., Brandt, C., Dettenkofer, M., Chaberny, I. F., Rüden, H., Geffers, C. (2008). Ten years of KISS. The most important requirements for success. *Journal of Hospital Infection*, 70, Suppl 1, p. 11–16.

Instructions for use/Exclusion of liability

This brochure has been compiled with the greatest of care. However, no liability for the correctness and completeness of its content is assumed.

Responsibility for concrete planning and compliance with recognised rules of technology lies solely with the planner in individual cases. This brochure does not represent the conclusion of any contractual relationship or relationship similar to a contract. The authors and the publisher are not responsible for the content of secondary sources.



Federal Institute for Research on Building, Urban Affairs and Spatial Development

within the Federal Office for
Building and Regional Planning



ZUKUNFT BAU
FORSCHUNGSFÖRDERUNG

www.zukunftbau.de

ISBN 978-3-87994-096-7
ISSN 2199-3521

Hygiene in health facilities plays a decisive role in protecting people from infections and thus serious progression of diseases. Persons who are already immunocompromised come into contact with one another in hospitals and further infectious diseases can occur during the course of their stay. Up to 500,000 people suffer from hospital infections every year in Germany and around 10,000 people die of them.

This brochure shows by means of planning recommendations how structural/functional processes in hospitals can be hygienically optimised, appropriate materials can be used and thus new building structures designed efficiently and sustainably. Under the leadership of the Technische Universität Braunschweig's Institute of Constructive Design, Industrial and Health Care Building (IKE), an interdisciplinary research team with experts from the Technische Universität Braunschweig's Institute for Construction Materials, Construction and Fire Safety (IBMB) and the Charité Universitätsmedizin Berlin's Institute for Hygiene and Environmental Medicine investigated this topic in the research project "HYBAU+ – Structural Hygiene in Hospitals".

The Zukunft Bau Innovation Programme has been providing important impulses for architecture and the building industry for ten years and builds bridges between building research and building practice. The main aim is to gain building-relevant knowledge about current research topics such as climate protection, material and resource efficiency, digitalisation, cost-effective construction and demographic change. The Zukunft Bau Innovation Programme provides a platform for researching, designing, testing and communicating corresponding innovative approaches, with the intention of not only sounding out new framework conditions in the building industry, but also of establishing research as a broader-scale method for planning and building. The Zukunft Bau Innovation Programme is supported by the Federal Ministry for Housing, Urban Development and Building (BMSWB) together with the Federal Institute for Research on Building, Urban Affairs and Spatial Development (BBSR).